

STAMINA® **PT 1690**

Owner's Manual

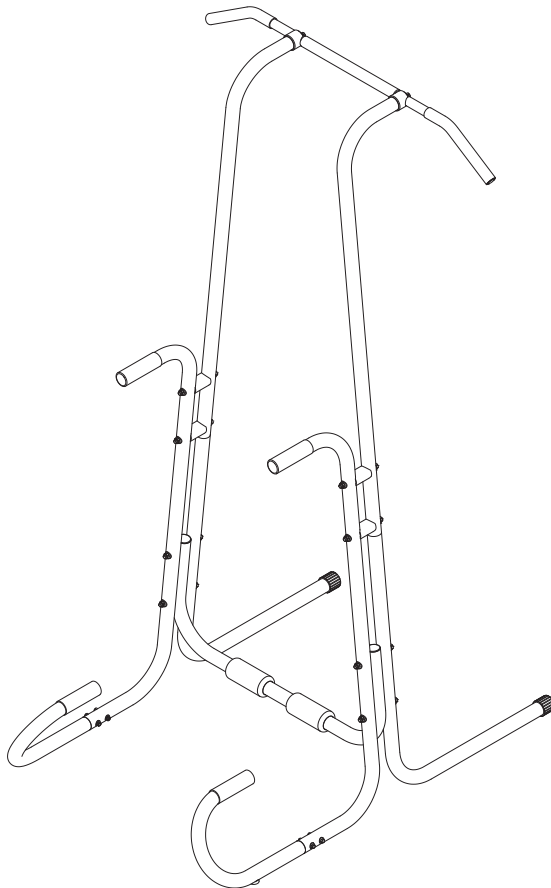

Product May Vary Slightly From Pictured.

CAUTION:

Weight on this product should not exceed 250 lbs.

⚠ WARNING

Exercise can present a health risk. Consult a physician before beginning any exercise program with this equipment. If you feel faint or dizzy, immediately discontinue use of this equipment. Serious bodily injury can occur if this equipment is not assembled and used correctly. Serious bodily injury can also occur if all instructions are not followed. Keep others and pets away from equipment when in use. Always make sure all bolts and nuts are securely tightened prior to each use. Follow all safety instructions in this manual.

When calling for parts or service, please specify the following number:

Model#: 50-1690B

This Product is Distributed Exclusively by



2040 N. Alliance, Springfield, MO 65803

Customer Service

1 (800) 375-7520

www.staminaproducts.com

STAMINA PRODUCTS
MADE IN CHINA

© 2012 Stamina Products, Inc.
2012, 03

TABLE OF CONTENTS

Safety Instructions	2	Warm-Up and Cool-Down	11
Before You Begin	4	Workout Instructions	12
Equipment Warning, Caution & Notice Labels ...	5	Product Parts Drawing	14
Hardware Identification Chart	6	Parts List	15
Assembly Instructions	7	Warranty	16
Storage	9	Notes	17
Maintenance	9	Fax/Mail Ordering Form	18
Conditioning Guidelines	10		

SAFETY INSTRUCTIONS

- ⚠ WARNING** This product contains a chemical known to the State of California to cause cancer and birth defects or other reproductive harm.
- ⚠ CAUTION** Consult your physician before starting this or any exercise program. This is especially important if you are over the age of 35, have never exercised before, are pregnant, or suffer from any health problem. This product is for home use only. Do not use in institutional or commercial applications. Failure to follow all warnings and instructions could result in bodily injury and property damage.
- ⚠ WARNING** To reduce the risk of serious injury, read the following Safety Instructions before using the PT 1690.

1. Read all warnings and cautions posted on the **PT 1690**.
2. The **PT 1690** should only be used after a thorough review of the Owner's Manual.
3. We recommend that two people be available for assembly of this product.
4. Keep children away from the **PT 1690**. Do not allow children to use or play on the **PT 1690**. Keep children and pets away from the **PT 1690** when it is in use.
5. It is recommended that you place this exercise equipment on an equipment mat.
6. Set up and operate the **PT 1690** on a solid level surface. Do not position the **PT 1690** on loose rugs or uneven surfaces.
7. Make sure that adequate space is available for access to and around the **PT 1690**.
8. Before using, inspect the **PT 1690** for worn or loose components, and securely tighten or replace any worn or loose components prior to use.
9. Consult a physician prior to commencing an exercise program and follow his/her recommendations in developing your fitness program. If at any time during exercise you feel faint, dizzy, or experience pain, stop and consult your physician.
10. Follow your physician's recommendations in developing your own personal fitness program.
11. Always choose the workout which best fits your physical strength and flexibility level. Know your limits and train within them. Always use common sense when exercising.
12. Do not wear loose or dangling clothing while using the **PT 1690**.
13. Never exercise in bare feet or socks; always wear proper footwear such as running, walking, or cross training shoes that fit well, provide foot support, and feature non-skid rubber soles.
14. Be careful to maintain your balance while using, mounting, dismounting, or assembling the **PT 1690**, loss of balance may result in a fall and serious bodily injury.
15. The **PT 1690** should not be used by persons weighing over 250 pounds.
16. The **PT 1690** should be used by only one person at a time.
17. The **PT 1690** is for consumer use only. It is not for use in public or semipublic facilities.

Call Us First



Customer Service
1 (800) 375-7520
www.staminaproducts.com

THANK YOU FOR PURCHASING THE PT 1690

To enact your warranty, please register your product
by going to register.staminaproducts.com

Your PT 1690 does require assembly.

Please follow the assembly steps set forth in this manual.

With regular workouts, you will be getting your body into shape
and be on your way to achieving a happier and healthier lifestyle.

Should you have any questions,
please call our Customer Service Department toll-free number,
1 (800) 375-7520

Monday - Thursday, 7:30 A.M. - 5:00 P.M., Central Time.

Friday, 8:00 A.M. - 3:00 P.M., Central Time.



ONLINE

CUSTOMER SERVICE
customerservice@staminaproducts.com
www.staminaproducts.com



TELEPHONE

CUSTOMER SERVICE
Tel: 1 (800) 375-7520



FAX

CUSTOMER SERVICE
Fax: (417) 889-8064



MAIL

STAMINA PRODUCTS, INC.
ATTN: Customer Service
P.O. Box 1071
Springfield, MO. 65801-1071



BEFORE YOU BEGIN

Thank you for choosing the **PT 1690**. We take great pride in producing this quality product and hope it will provide many hours of quality exercise to make you feel better, look better, and enjoy life to its fullest.

It's a proven fact that a regular exercise program can improve your physical and mental health. Too often, our busy lifestyles limit our time and opportunity to exercise. The **PT 1690** provides a convenient and simple method to begin your assault on getting your body in shape and achieving a happier and healthier lifestyle.

Before reading further, please review the drawing below and familiarize yourself with the parts that are labeled.

Read this manual carefully before using the **PT 1690**.

Although Stamina constructs its products with the finest materials and uses the highest standards of manufacturing and quality control, there can sometimes be missing parts or incorrectly sized parts. If you have any questions or problems with the parts included with your **PT 1690**, please do not return the product. Contact us **FIRST!**

If a part is missing or defective, please go to staminaproducts.com to the Services section and order the part needed, or call us toll free at 1-800-375-7520 (in the U.S.). Our Customer Service Staff is available to assist you from 7:30 A.M. to 5:00 P.M. (Central Time) Monday through Thursday and 8:00 A.M. to 3:00 P.M. (Central Time) on Friday.

Be sure to have the name and model number of the product available when you contact us.

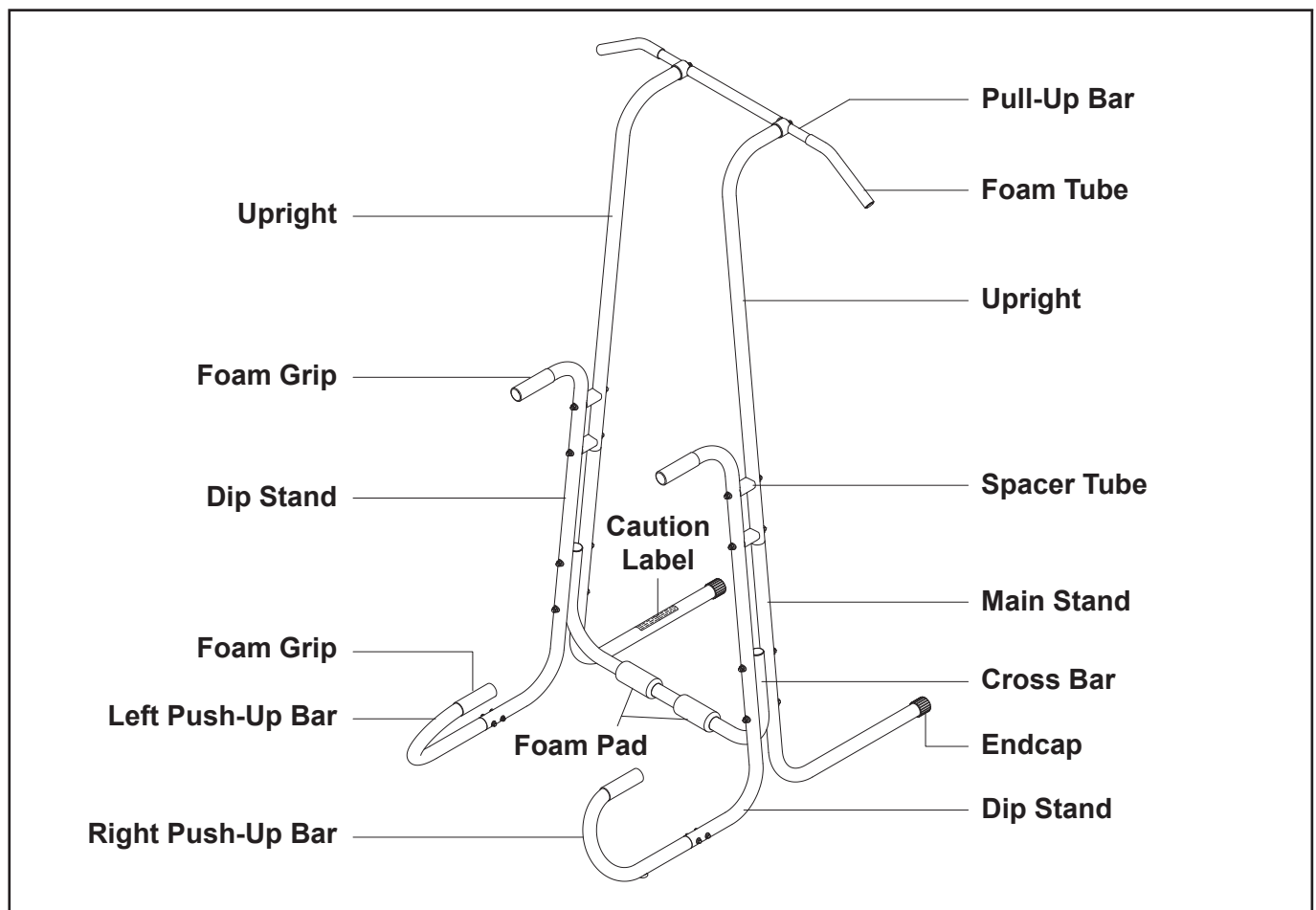

THE FOLLOWING TOOLS ARE INCLUDED FOR ASSEMBLY:

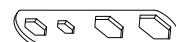

Wrench (2 pieces)

EQUIPMENT WARNING, CAUTION & NOTICE LABELS

This chart is provided to help identify the warning, caution, and notice labels on the **PT 1690**. Please take a moment to familiarize yourself with all of the warning, caution, and notice labels.

Label is larger than actual size

C1 CAUTION LABEL(30)

CAUTION

Failure to follow all warnings and instructions could result in injury or property damage. Before assembling or using this product, read and follow the Owner's Manual and all other warnings and instructions that accompany this product. Replace this caution label if damaged, illegible, or removed.

Keep others including children & pets away from equipment when in use.

Consult your physician before starting this or any exercise program. This is especially important if you are over the age of 35 or have any pre-existing health condition. Always make sure all nuts and bolts are securely tightened before using this product. This product should not be used by person weighing more than 250 lbs. unless otherwise stated in your Owner's Manual.

HARDWARE IDENTIFICATION CHART

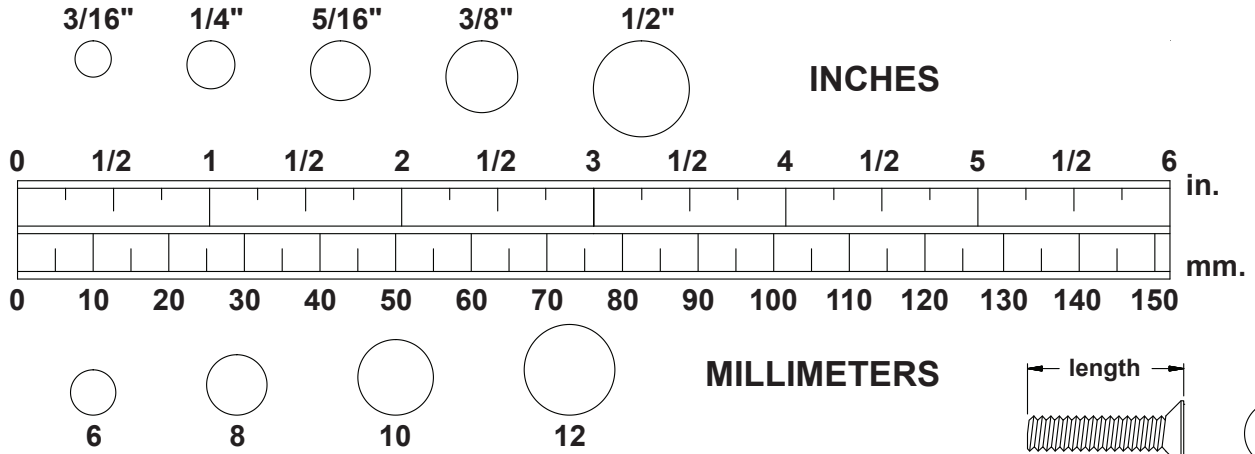

This chart is provided to help identify the hardware used in the assembly process. Place the washers or the ends of the bolts or screws on the circles to check for the correct diameter. Use the small scale to check the length of the bolts and screws.

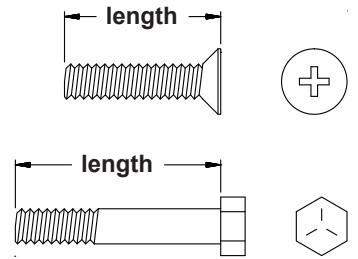

NOTICE: The length of all bolts and screws, except those with flat heads, is measured from below the head to the end of the bolt or screw. Flat head bolts and screws are measured from the top of the head to the end of the bolt or screw.

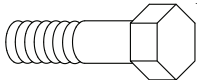
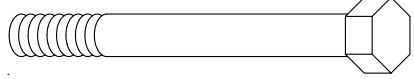
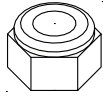

After unpacking the unit, open the hardware bag and make sure that you have all the following items. Some hardware may be already attached to the part.

	Part Number and Description	Qty
	19 Bolt, Hex Head (M6 x 1 x 48mm)	4
	20 Bolt, Hex Head (M8 x 1.25 x 50mm)	2
	21 Bolt, Hex Head (M10 x 1.5 x 130mm)	8
	22 Nylock Nut (M6 x 1)	4
	23 Nylock Nut (M10 x 1.5)	8
	24 Arc Washer (M6)	8
	25 Arc Washer (M8)	2
	26 Arc Washer (M10)	16

ASSEMBLY INSTRUCTIONS

Place all parts from the box in a cleared area and position them on the floor in front of you. Remove all packing materials from your area and place them back into the box. Do not dispose of the packing materials until assembly is completed. Read each step carefully before beginning. If you are missing a part, please go to staminaproducts.com under the Service section and order the part needed, e-mail us at customerservice@staminaproducts.com, or call us toll free at 1-800-375-7520 (in the U.S.). Our Customer Service Staff is available to assist you from 7:30 A.M. to 5:00 P.M. (Central Time) Monday through Thursday and 8:00 A.M. to 3:00 P.M. (Central Time) on Friday.

NOTE: DO NOT SECURELY TIGHTEN ALL BOLTS UNTIL STEP 4.

STEP 1

Bolt the **MAIN STAND(1)**, **CROSS BAR(4)**, and **DIP STAND(5)** together with **HEX BOLTS (M10x1.5x130mm)(21)**, **ARC WASHERS(M10)(26)**, and **NYLOCK NUTS(M10x1.5)(23)**. Repeat on other side.

STEP 2

There is an “L” decal on the **LEFT PUSH-UP BAR(6)**, and an “R” decal on the **RIGHT PUSH-UP BAR(7)**. Insert the **LEFT PUSH-UP BAR(6)** into the **DIP STAND(5)** on the left side and secure with **HEX BOLTS(M6x1x48mm)(19)**, **ARC WASHERS(M6)(24)**, and **NYLOCK NUTS(M6x1)(22)**. Repeat on the right side.

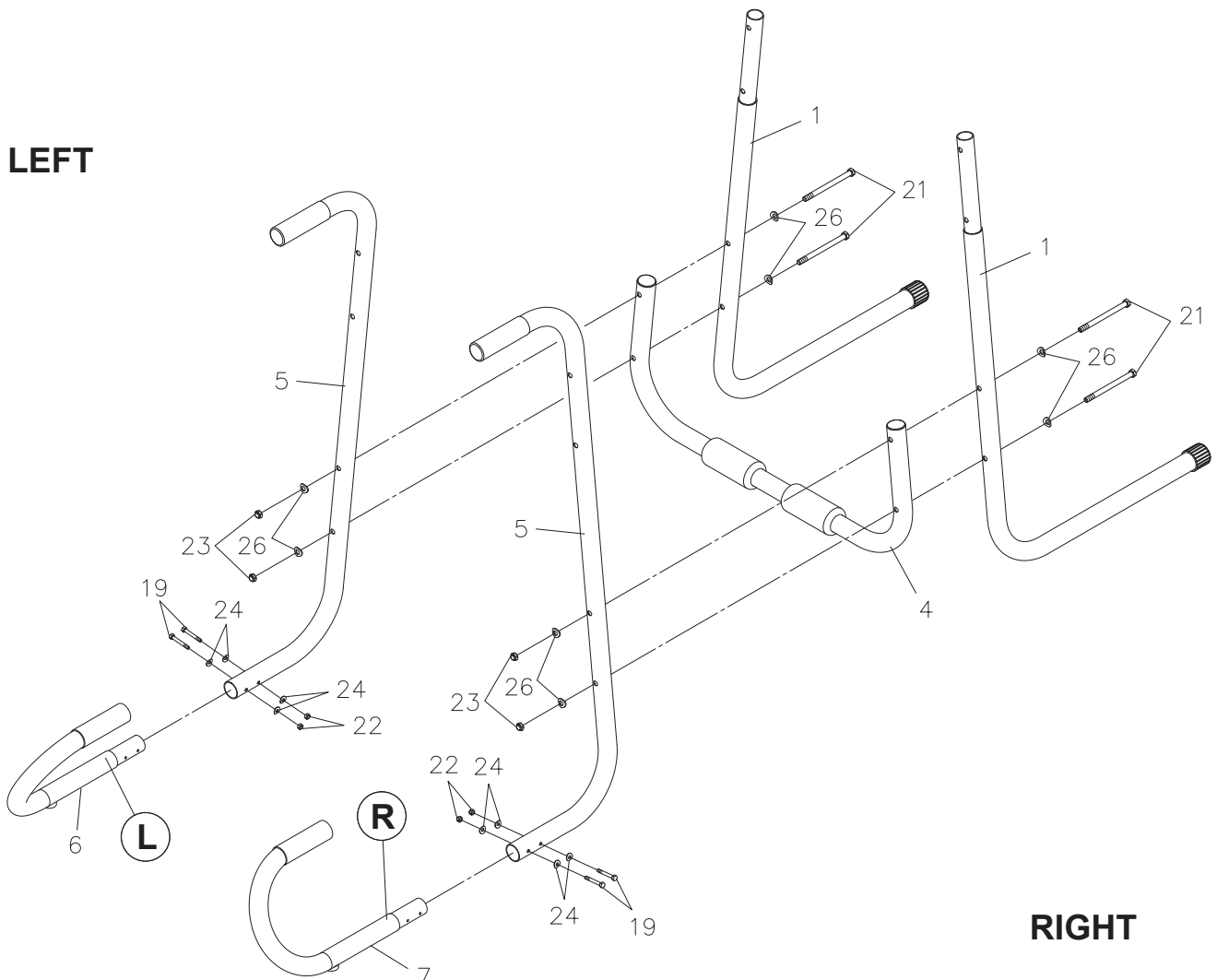

ASSEMBLY INSTRUCTIONS

STEP 3

Insert the two **UPRIGHTS(2)** onto the **MAIN STANDS(1)**. Place a **ARC WASHER(M10)(26)** onto a **HEX BOLT(M10x1.5x130mm)(21)**. Slide a **SPACER TUBE(11)** between the **UPRIGHT(2)** and the **DIP STAND(5)**, then insert the bolt through all these tubes and bolt them together with a **ARC WASHER(M10)(26)** and a **NYLOCK NUT(M10x1.5)(23)**. Repeat to assemble the other **SPACER TUBES(11)** between the **UPRIGHT(2)** and the **DIP STAND(5)**.

NOTE: When assembling the **SPACER TUBE(11)**, start from the one at the lower position.

STEP 4

Attach the **PULL-UP BAR(3)** to both the **UPRIGHTS(2)** with **HEX BOLTS(M8x1.25x50mm)(20)** and **ARC WASHERS(M8)(25)**.

SECURELY TIGHTEN ALL OF THE BOLTS FROM STEP 1 TO STEP 4.

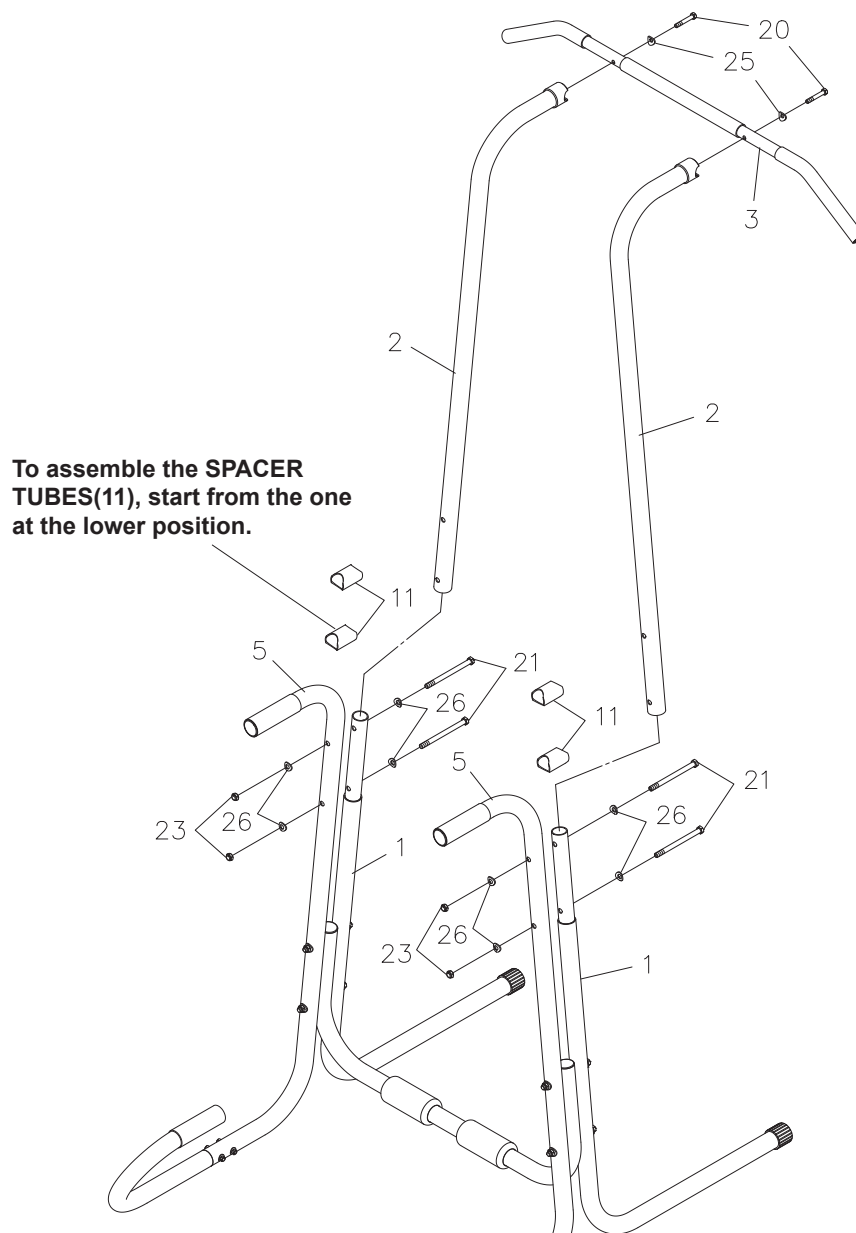

STORAGE

1. To store the **PT 1690**, simply keep it in a clean dry place.
2. Use two people to lift from the **DIP STANDS(5)** and **UPRIGHTS(2)** on both sides to move the **PT 1690**.

MAINTENANCE

The safety and integrity designed into the **PT 1690** can only be maintained when the **PT 1690** is regularly examined for damage and wear. Special attention should be given to the following:

1. Verify that the **CAUTION LABEL(30)** is in place and easy to read. Call Stamina Products immediately at **1-800-375-7520** for a replacement **CAUTION LABEL(30)** if it is missing or damaged.
2. It is the sole responsibility of the user/owner to ensure that regular maintenance is performed.
3. Verify that all nuts and bolts are present and properly tightened. Replace missing nuts and bolts. Securely tighten loose nuts and bolts.
4. Worn or damaged components shall be replaced immediately or the **PT 1690** removed from service until repair is made.
5. Only Stamina Products supplied components shall be used to maintain/repair the **PT 1690**.
6. Keep your **PT 1690** clean by wiping it off with an absorbent cloth after use.

CONDITIONING GUIDELINES

How you begin your exercise program depends on your physical condition. If you have been inactive for several years or are severely overweight, start slowly and increase your workout time gradually. Increase your workout intensity gradually by monitoring your heart rate while you exercise.

Remember to follow these essentials:

- Have your doctor review your training and diet programs.
- Begin your training program slowly with realistic goals that have been set by you and your physician.
- Warm up before you exercise and cool down after you work out.
- Take your pulse periodically during your workout and strive to stay within a range of 60% (lower intensity) to 90% (higher intensity) of your maximum heart rate zone. Start at the lower intensity, and build up to higher intensity as you become more aerobically fit.
- If you feel dizzy or lightheaded you should slow down or stop exercising.

Initially you may only be able to exercise within your target zone for a few minutes; however, your aerobic capacity will improve over the next six to eight weeks. It is important to pace yourself while you exercise so you don't tire too quickly.

To determine if you are working out at the correct intensity, use a heart rate monitor or use the table below. For effective aerobic exercise, your heart rate should be maintained at a level between 60% and 90% of your maximum heart rate. If just starting an exercise program, work out at the low end of your target heart rate zone. As your aerobic capacity improves, gradually increase the intensity of your workout by increasing your heart rate.

Measure your heart rate periodically during your workout by stopping the exercise but continuing to move your legs or walk around. Place two or three fingers on your wrist and take a six second heartbeat count. Multiply the results by ten to find your heart rate. For example, if your six second heartbeat count is 14, your heart rate is 140 beats per minute. A six second count is used because your heart rate will drop rapidly when you stop exercising. Adjust the intensity of your exercise until your heart rate is at the proper level.

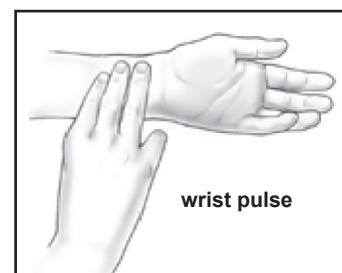

Target Heart Rate Zone Estimated by Age*

Age	Target Heart Rate Zone (55%-90% of Maximum Heart Rate)	Average Maximum Heart Rate 100%
20 years	110-180 beats per minute	200 beats per minute
25 years	107-175 beats per minute	195 beats per minute
30 years	105-171 beats per minute	190 beats per minute
35 years	102-166 beats per minute	185 beats per minute
40 years	99-162 beats per minute	180 beats per minute
45 years	97-157 beats per minute	175 beats per minute
50 years	94-153 beats per minute	170 beats per minute
55 years	91-148 beats per minute	165 beats per minute
60 years	88-144 beats per minute	160 beats per minute
65 years	85-139 beats per minute	155 beats per minute
70 years	83-135 beats per minute	150 beats per minute

* For cardiorespiratory training benefits, the American College of Sports Medicine recommends working out within a heart rate range of 55% to 90% of maximum heart rate. To predict the maximum heart rate, the following formula was used: $220 - \text{Age} = \text{predicted maximum heart rate}$

WARM-UP and COOL-DOWN

Warm-Up The purpose of warming up is to prepare your body for exercise and to minimize injuries. Warm up for two to five minutes before strength training or aerobic exercising. Perform activities that raise your heart rate and warm the working muscles. Activities may include brisk walking, jogging, jumping jacks, jump rope, and running in place

Stretching Stretching while your muscles are warm after a proper warm-up and again after your strength or aerobic training session is very important. Muscles stretch more easily at these times because of their elevated temperature, which greatly reduces the risk of injury. Stretches should be held for 15 to 30 seconds. Do not bounce.

Suggested Stretching Exercises

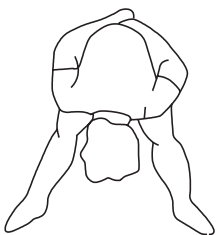

Lower Body Stretch

Place feet shoulder-width apart and lean forward. Keep this position for 30 seconds using the body as a natural weight to stretch the backs of the legs. **DO NOT BOUNCE!** When the pull on the back of the legs lessens, gradually try a lower position.

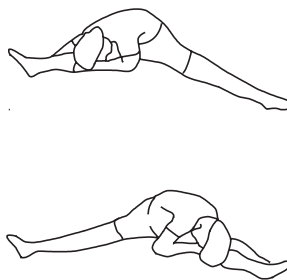

Floor Stretch

While sitting on the floor, open the legs as wide as possible. Stretch the upper body toward the knee on the right leg by using your arms to pull your chest to your thighs. Hold this stretch 10 to 30 seconds. **DO NOT BOUNCE!** Do this stretch 10 times. Repeat the stretch with the left leg.

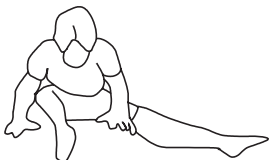

Bent Torso Pulls

While sitting on the floor, have legs apart, one leg straight and one knee bent. Pull the chest down to touch the thigh on the leg that is bent, and twist at the waist. Hold this position at least 10 seconds. Repeat 10 times on each side.



Bent Over Leg Stretch

Stand with feet shoulder-width apart and lean forward as illustrated. Using the arms, **gently** pull the upper body towards the right leg. Let the head hang down. **DO NOT BOUNCE!** Hold the position a minimum of 10 seconds. Repeat pulling the upper body to the left leg. Do this stretch several times slowly.

Remember to always check with your physician before starting any exercise program.

Cool-Down The purpose of cooling down is to return the body to its normal, or near normal, resting state at the end of each exercise session. A proper cool-down slowly lowers your heart rate and allows blood to return to the heart. Your cool-down should include the stretches listed above and should be completed after each strength training session.

WORKOUT INSTRUCTIONS

Dips:

A variation can be to lower yourself from the start position to only halfway down.



Start



Finish

Push-Ups:

A variation can be to lower yourself from the start position to only halfway down.



Start



Finish

Lat Pull-Ups:

Variations can include using a medium or narrow grip.



Start



Finish

WORKOUT INSTRUCTIONS

Vertical Knee Raise:

Variations can include alternately raising each leg or bringing the legs up in a twisting motion.



Start



Finish

Sit-Ups:

A variation can be to twist your torso as you sit up.



Start



Finish

PRODUCT PARTS DRAWING

FRONT

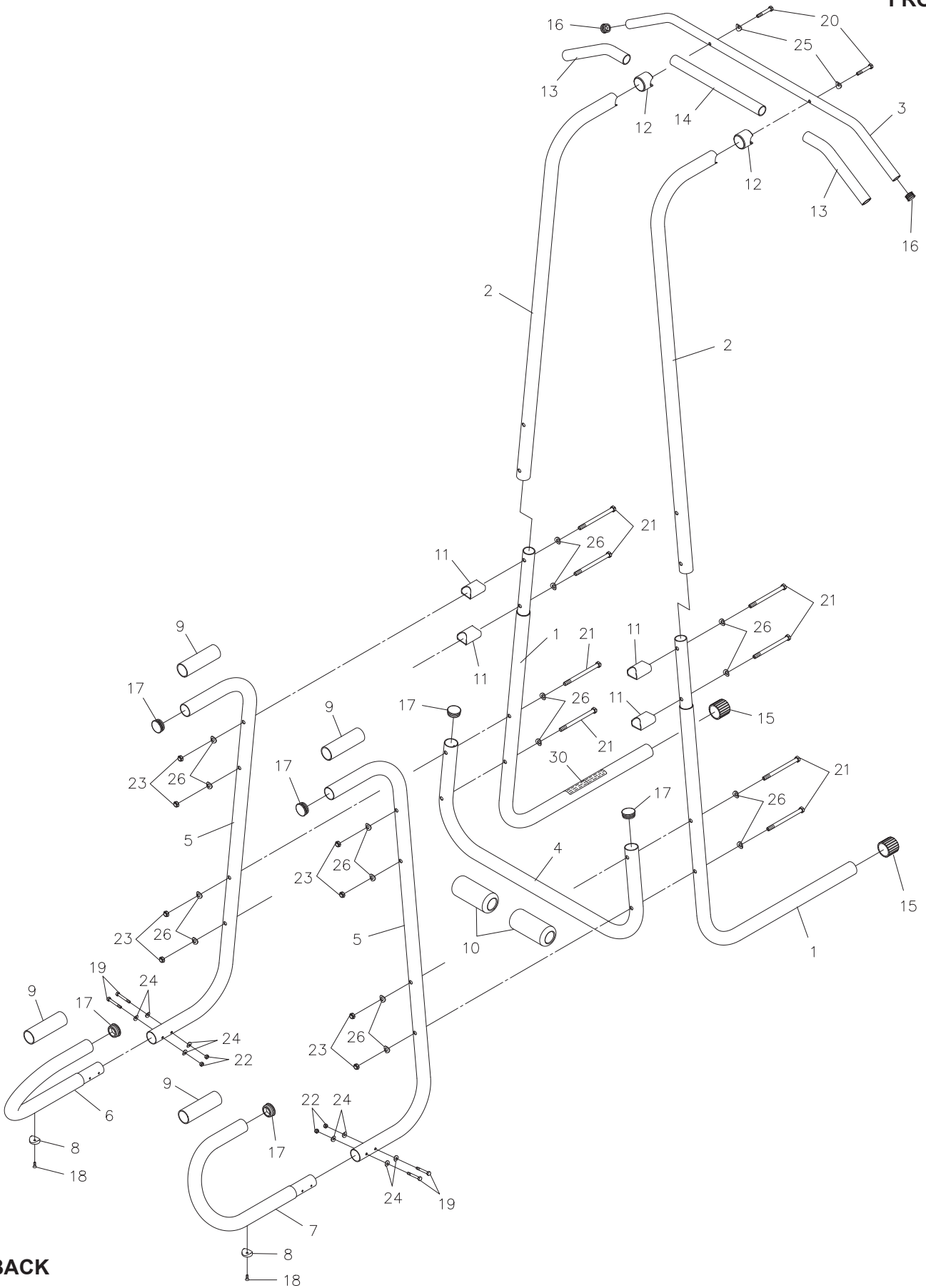

PARTS LIST

PART#	PART NAME	QTY
1	Main Stand	2
2	Upright	2
3	Pull-Up Bar	1
4	Cross Bar	1
5	Dip Stand	2
6	Left Push-Up Bar	1
7	Right Push-Up Bar	1
8	Foot Stand	2
9	Foam Grip	4
10	Foam Pad	2
11	Spacer Tube	4
12	Connective Cap	2
13	Foam Tube (ø22 x ø32 x 265mm)	2
14	Long Foam Tube (ø22 x ø32 x 350mm)	1
15	Endcap (38.1mm)	2
16	Round Plug (25.4mm)	2
17	Round Plug (38.1mm)	6
18	Screw, Flat Head (M5 x 0.8 x 15mm)	2
19	Bolt, Hex Head (M6 x 1 x 48mm)	4
20	Bolt, Hex Head (M8 x 1.25 x 50mm)	2
21	Bolt, Hex Head (M10 x 1.5 x 130mm)	8
22	Nylock Nut (M6 x 1)	4
23	Nylock Nut (M10 x 1.5)	8
24	Arc Washer (M6)	8
25	Arc Washer (M8)	2
26	Arc Washer (M10)	16
28	Wrench	2
29	Manual	1
30	Caution Label	1

LIMITED WARRANTY

MODEL 50-1690B

WARRANTY

Stamina Products, Inc. warrants that this product will be free from defects in materials and workmanship under normal use, service and proper operation for a period of 90 days on the parts and five years on the frame from the date of the original purchase from an authorized retailer. **THIS WARRANTY SHALL NOT APPLY TO ANY PRODUCT WHICH HAS BEEN SUBJECT TO COMMERCIAL USE, ABUSE, MISUSE, ALTERATION OF ANY TYPE OR CAUSE OR TO ANY DEFECT OR DAMAGE CAUSED BY REPAIR, REPLACEMENT, SUBSTITUTION OR USE WITH PARTS OTHER THAN PARTS PROVIDED BY STAMINA PRODUCTS, INC.** Commercial use includes use of the product in athletic clubs, health clubs, spas, gymnasiums, exercise facilities, and other public or semipublic facilities whether or not the product's use is in furtherance of a profit making enterprise, and all other use which is not for personal, family, or household purposes.

To implement this limited warranty, send a written notice stating your name, date, and place of purchase and a brief description of the defect along with your receipt to **Stamina Products, Inc. P.O. Box 1071, Springfield Missouri, USA, 65801-1071**, or email us at **customerservice@staminaproducts.com**, or call us at **1-800-375-7520**. If the defect is covered under this limited warranty, you will be requested to return the product or part to us for free repair or replacement at our option. **NO ACTION FOR BREACH OF THIS LIMITED WARRANTY MAY BE COMMENCED MORE THAN ONE (1) YEAR AFTER THE DATE THE ALLEGED BREACH WAS OR SHOULD HAVE BEEN DISCOVERED. NO ACTION FOR BREACH OF ANY IMPLIED WARRANTY MAY BE COMMENCED MORE THAN ONE (1) YEAR AFTER DELIVERY OF THE PRODUCT TO THE PURCHASER.** This limited warranty is not transferable. **IF ANY PART OF THE PRODUCT IS NOT IN COMPLIANCE WITH THIS LIMITED WARRANTY OR ANY IMPLIED WARRANTY, THE REMEDY OF REPAIR OR REPLACEMENT IS THE EXCLUSIVE REMEDY AVAILABLE TO YOU.** In the event that the purchaser makes any claim under this limited warranty or any implied warranty, the Warrantor reserves the right to require the product to be returned for inspection, at the purchaser's expense, to the Warrantor's premises in Springfield, Missouri. Return of the enclosed warranty registration card is not required for warranty coverage, but is merely a way of establishing the date and place of purchase.

Stamina Products, Inc. **SHALL NOT BE LIABLE FOR THE LOSS OF USE OF ANY PRODUCT, LOSS OF TIME, INCONVENIENCE, COMMERCIAL LOSS OR ANY OTHER INDIRECT, CONSEQUENTIAL, SPECIAL OR INCIDENTAL DAMAGES DUE TO BREACH OF THE ABOVE WARRANTY OR ANY IMPLIED WARRANTY.**

This limited warranty is the only written or express warranty given by Stamina Products, Inc. This warranty gives you specific legal rights, and you may also have other legal rights which vary from state to state. **ANY OTHER RIGHT WHICH YOU MAY HAVE, INCLUDING ANY IMPLIED WARRANTY OR MERCHANTABILITY OR FITNESS FOR A PARTICULAR PURPOSE, IS LIMITED IN DURATION TO THE DURATION OF THIS WARRANTY.**

The laws in some jurisdictions restrict the rights of manufacturers and distributors of consumer goods to disclaim or limit implied warranties and consequential and incidental damages with respect thereto. If any such law is found to be applicable, the foregoing disclaimers and limitations of and on implied warranties and consequential and incidental damages with respect thereto shall be disregarded and shall be deemed not to have been made to the extent necessary to comply with such legal restriction.

NOTES

TO CONTACT CUSTOMER SERVICE

For your convenience, Stamina's customer service representatives can be reached by email at customerservice@staminaproducts.com or by phone at 1-800-375-7520 (in the U.S.). Our customer service representatives are available Monday through Thursday from 7:30 a.m. until 5:00 p.m., and Friday 8:00 a.m. until 3 p.m. Central Time.



**ONLINE
CUSTOMER SERVICE**
customerservice@staminaproducts.com
www.staminaproducts.com



**TELEPHONE
CUSTOMER SERVICE**
Tel: 1 (800) 375-7520



**FAX
CUSTOMER SERVICE**
Fax: (417) 889-8064



**MAIL
STAMINA PRODUCTS, INC.**
ATTN: Customer Service
P.O. Box 1071 Springfield, MO. 65801-1071

Would you like to receive email information or special offers from Stamina Products? Register at contact.staminaproducts.com

TO REGISTER YOUR PRODUCT

To enact your warranty, please register your product by going to register.staminaproducts.com. Please have your product model number (printed on the cover of this owner's manual) and the serial number (printed on the black and white sticker on your product) ready.

If you don't have internet access, you can call customer service at 1-800-375-7520, or fill out and mail the product registration form below to Stamina Products, Inc.; P.O. Box 1071; Springfield, MO 65801-1071.

PRODUCT REGISTRATION FORM	Stamina Products, Inc. P.O. Box 1071 Springfield, MO 65801-1071
Model Number:	Serial Number:
Product Name:	
Place Purchased:	
Date of Purchase:	Purchase Price:
First Name:	Last Name:
City:	State: Zip Code:
Email Address:	Phone #: ()
Would you like to receive email information or special offers from Stamina Products?* <input type="checkbox"/> Yes <input type="checkbox"/> No *If yes, be sure your email address is included above.	



Detach and Mail or Fax the Form Above



TO ORDER PARTS

If there are missing or damaged parts, you can go to parts.staminaproducts.com and order those parts. If you have questions, please contact customer service. Do not return the product. To order parts by mail, fill out the sheet below and fax it to 417-889-8064. The part will be mailed to your address.



Detach and Mail or Fax the Form Below



PARTS ORDER FORM	Stamina Products, Inc. P.O. Box 1071 Springfield, MO 65801-1071
Mr./Ms:	
Address: Apt. #:	
City: State: Zip Code:	
IMPORTANT : We must have your phone number to process the order!	
Phone #: () Work Phone #: ()	
Date of Purchase:	
Model #:	
Purchased From:	

**IMPORTANT : Before filling out the form below make sure you have the correct information.
Refer to the parts list to make sure you're ordering the right parts!**

PART #	DESCRIPTION	QUANTITY
EXAMPLE: 1	Rear Unit Assembly	1