

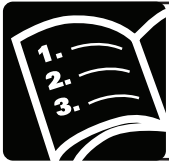

# PR1000 Home Gym

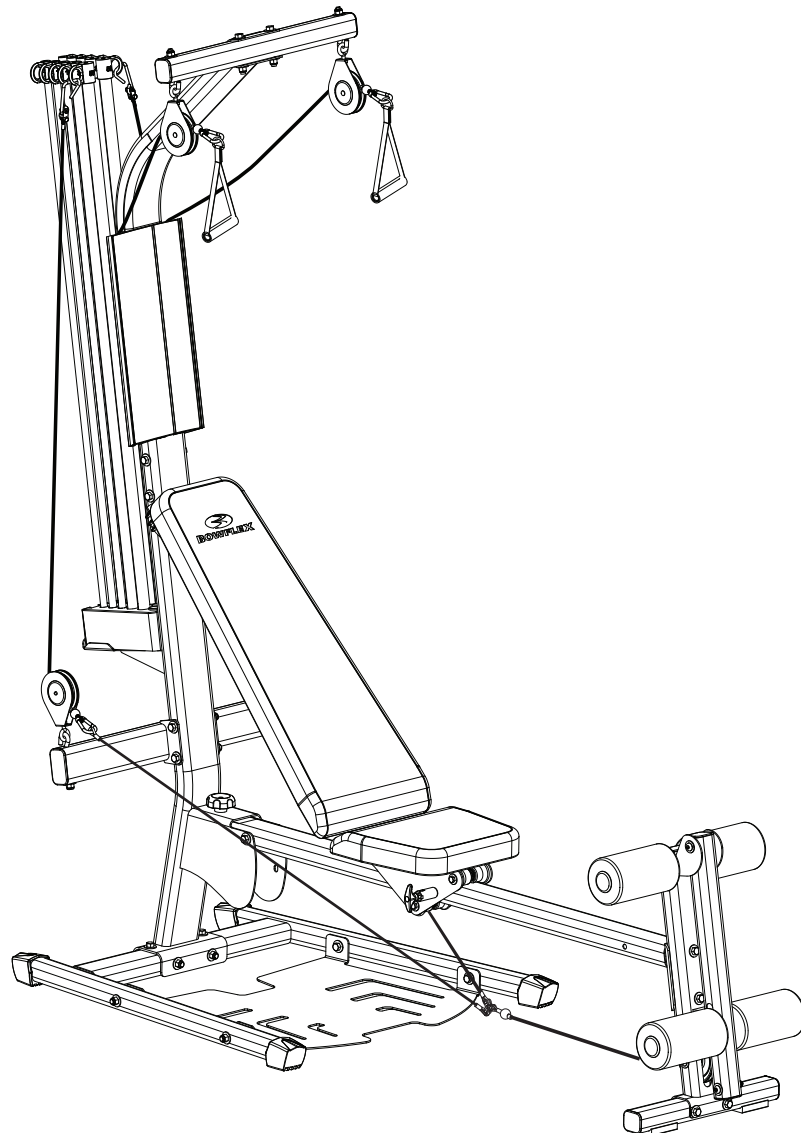

Owner's Manual



# Table of Contents

<b>Specifications</b> .....	<b>2</b>	<b>Exercises</b> .....	<b>20</b>
<b>Important Safety Instructions</b> .....	<b>3</b>	Aerobic Rowing .....	20
Safety Warning Labels and Serial Number.....	4	Bench Press.....	21
<b>Features and Use</b> .....	<b>6</b>	Decline Bench Press .....	21
How Often Should You Exercise.....	6	Incline Bench Press.....	22
What to Wear .....	6	Seated Shoulder Press.....	22
Stretching .....	6	Front Shoulder Raise.....	23
Power Rod® Resistance.....	8	Crossover Seated Rear Deltoid Rows.....	23
Adjusting and Understanding the Resistance .....	8	Scapular Retraction .....	24
Connecting the Power Rod® Unit to the Cables.....	8	Narrow Pulldowns.....	24
Safety.....	8	Stiff Arm Pulldowns.....	25
When You Are Not Using Your Home Gym .....	8	Seated Lat Rows.....	25
The Workout Bench .....	9	Reverse Grip Pulldown .....	26
Maintenance and Care of Your Gym .....	9	Seated Low Back Extension .....	26
Storing Your Home Gym.....	10	Triceps Pushdown .....	27
Accessories and Equipment.....	11	Lying Triceps Extension .....	27
<b>Workouts</b> .....	<b>12</b>	Standing Biceps Curl .....	28
Define Your Goals .....	12	Standing Wrist Curl .....	28
Design Your Program .....	13	Seated (Resisted) Abdominal Crunch .....	29
Twenty Minute Better Body Workout.....	14	Trunk Rotation .....	29
Advanced General Conditioning .....	14	Leg Extension .....	30
Twenty Minute Upper/Lower Body.....	15	Calf Raise .....	30
Body Building .....	16	Seated Hip Adduction.....	31
Circuit Training - Anaerobic/Cardiovascular .....	17	Seated Hip Abduction.....	31
True Aerobic Circuit Training.....	18	Standing Leg Kickback .....	32
Strength Training.....	19	Leg Press .....	32
		<b>Contacts</b> .....	<b>36</b>

## Specifications

### Physical Dimensions

Length (not in use) .....	82" (208cm)
Length (maximum in use).....	103" (262cm)
Width (maximum in use) .....	80" (203cm)
Height.....	82" (209cm)
Weight .....	131 lbs. (59.5kg)

Box Weight.....	145 lbs. (65.8kg)
Box Dimensions.....	54"l x 33"w x 8"h (137cm x 84cm x 21cm)

### Capacities

Maximum Weight Capacity .....	300 lbs. (136kg)
-------------------------------	------------------

To validate warranty support, keep the original proof of purchase and record the following information:

**Serial Number** \_\_\_\_\_

**Date of Purchase** \_\_\_\_\_

To register your product warranty, go to: [www.bowflex.com/register](http://www.bowflex.com/register)

Or call 1 (800) 605-3369.

If you have questions or problems with your product, please call 1 (800) NAUTILUS (628-8458).

# Important Safety Instructions



This icon means a potentially hazardous situation which, if not avoided, could result in death or serious injury.

## Before using this equipment, obey the following warnings



Read and understand the complete Owner's Manual. Keep Owner's Manual for future reference.

Read and understand all warnings on this machine. If at any time the Warning stickers become loose, unreadable or dislodged, contact Nautilus® Customer Service for replacement stickers.

- Children must not be let on or near to this machine. Moving parts and other features of the machine can be dangerous to children.
- Not intended for use by anyone under 14 years of age.
- Consult a physician before you start an exercise program. Stop exercising if you feel pain or tightness in your chest, become short of breath, or feel faint. Contact your doctor before you use the machine again.
- Before each use, examine this machine for loose parts or signs of wear. Inspect all cables, pulleys and their connections, making sure they are properly secured and attached, and show no signs of visible wear or damage. Contact Nautilus® Customer Service for repair information.
- Maximum user weight limit: 300 lb. (136 kg). Do not use if you are over this weight.
- This machine is for home use only.
- Do not wear loose clothing or jewelry. This machine contains moving parts. Do not put fingers or other objects into moving parts of the exercise equipment.
- Always wear rubber soled athletic shoes when you use this machine. Do not use the machine with bare feet or only wearing socks.
- Set up and operate this machine on a solid, level, horizontal surface.
- Do not operate this machine outdoors or in moist or wet locations.
- Keep at least 36" (0.9m) on each side of the machine clear. This is the recommended safe distance for access and passage around and emergency dismounts from the machine. Keep third parties out of this space when machine is in use.
- Do not over exert yourself during exercise. Operate the machine in the manner described in this manual.
- Do not use Dumbbells or other weight equipment to incrementally increase the weight resistance. Use only the weight resistance that came with your gym.
- Correctly engage the Selector Hook to the Rod End.
- Correctly adjust and safely engage all Positional Adjustment Devices. Make sure that the Adjustment Devices do not hit the user.
- Keep clear of Power Rod® movement path during operation. Keep any bystanders clear of machine and Power Rod® movement path during operation.

# Important Safety Instructions

## Safety Warning Labels and Serial Number

Locate and read all safety warnings before operation. Replace any warning label if it is damaged, illegible, or missing. For replacement labels, call a Nautilus® Representative. Refer to the Contacts page at the back of this manual.

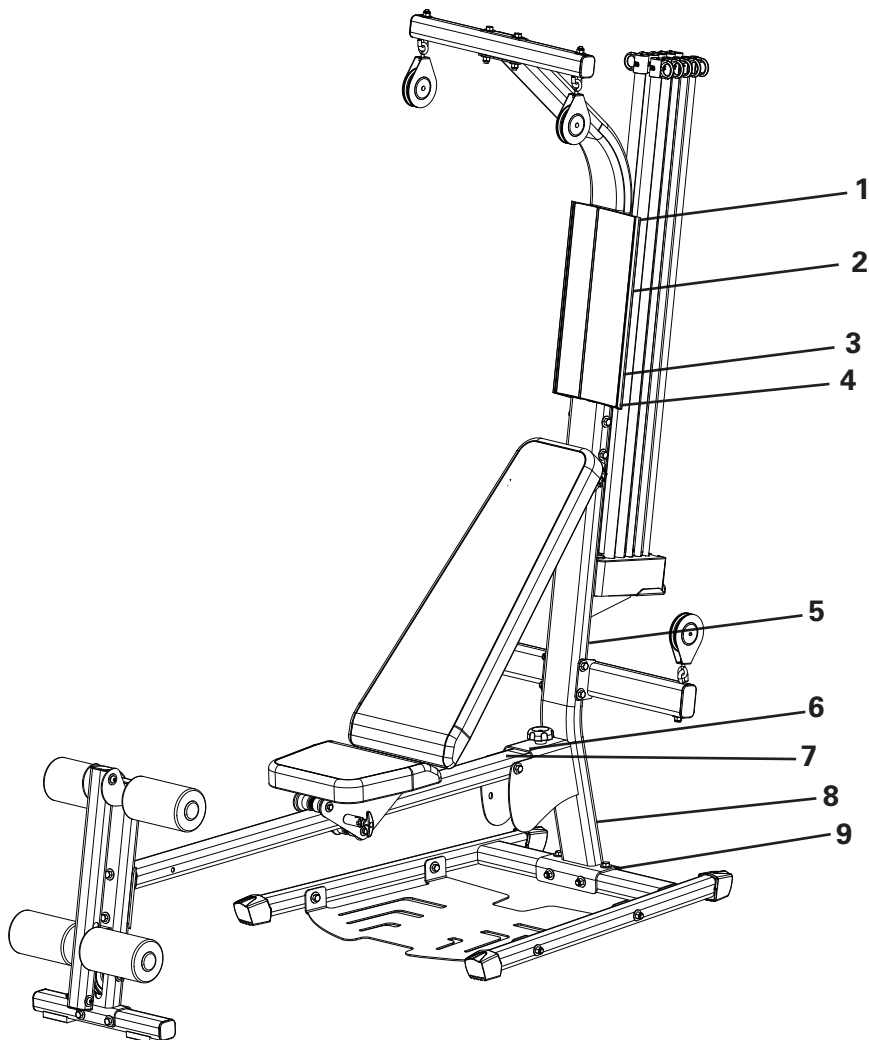

Type	Description
1* CAUTION	Before each use check all snap hooks, cables and pulleys for wear and proper function. Tighten all fasteners as necessary.
MISE EN GARDE	Avant chaque utilisation, vérifiez le fonctionnement de tous les mousquetons, câbles et poulies. Serrez bien toutes les fixations au besoin.
VORSICHT	Überprüfen Sie alle Karabinerhaken, Kabel und Rollen vor jeder Benutzung auf Abnutzungserscheinungen und Fehlfunktionen. Ziehen Sie alle Befestigungselemente ordnungsgemäß an.
PRECAUCIÓN	Antes de cada uso, revise todos los cierres a presión, cables y poleas para asegurarse de que no estén desgastados y que funcionan correctamente. Apriete todos los sujetadores según sea necesario.

# Important Safety Instructions

	Type	Description
2*	WARNING	The Maximum User Weight for this machine is 300 pounds (136 KG). This machine is for Home use only.
	WARNUNG	Das Maximale Belastungsgewicht für diese Maschine beträgt 136 kg. Dieses Gerät ist nur für die Nutzung im Heimbereich freigegeben.
	AVERTISSEMENT	Le poids maximum de l'utilisateur pour cette machine est de 136 kg (300 livres). Cet équipement est destiné à un usage privé uniquement.
	ADVERTENCIA	El peso máximo para el usuario de esta Máquina es de 136 kg (300 libras). Este equipamiento sólo se puede utilizar en el hogar.
3*	WARNING	<ul style="list-style-type: none"> <li>* Misuse or abuse of this equipment may lead to serious injury.</li> <li>* Keep children away and supervise teenagers using equipment.</li> <li>* Obtain, read and understand the owner's manual provided with this fitness equipment prior to use.</li> <li>* Replace this or any other warning label if damaged, illegible or missing.</li> </ul>
4*	AVERTISSEMENT	<ul style="list-style-type: none"> <li>• Soyez prudent lorsque vous utilisez cet équipement pour ne pas vous infliger de graves blessures.</li> <li>• Gardez les enfants et les animaux de compagnie éloignés de cette machine en tout temps.</li> <li>• Lisez et familiarisez-vous avec le Manuel du propriétaire et avec tous les avertissements avant d'utiliser cette machine.</li> <li>• Remplacez toute étiquette d'avertissement endommagée, illisible ou manquante.</li> </ul>
5*	CAUTION	At all times, stay out of the paths of moving rods.
	MISE EN GARDE	Restez toujours à l'écart des tiges mobiles.
	VORSICHT	Halten Sie stets Abstand zu beweglichen Stangen.
	PRECAUCIÓN	En todo momento, manténgase alejado del trayecto de las barras móviles.
6	NOTICE	Knob must be fully engaged.
		Le bouton doit être complètement enfoncé.
		Der Knopf muss vollständig eingerastet sein.
		La perilla debe estar completamente insertada.
7	CAUTION	Pictograph - Do not place hand here.
8*	NOTICE	Engineered in the USA, Made in China
9*	Serial Number	Record serial number on Contacts page at end of this manual.
* decal is located on back of Lat Tower.		

# Features and Use

## **Consult your physician before starting any exercise program.**

If you have not exercised recently, are pregnant, have a heart condition, or any physical limitation, consult with your physician before you use your machine. If you experience tightness in your chest, an irregular heartbeat, shortness of breath, feel faint, lightheaded or dizzy, or have any pain, STOP and consult your physician immediately.

## **How Often Should You Exercise**

- 3 times a week for 20 minutes each day.
- Schedule workouts in advance and try to follow the schedule.

## **What to Wear**

Wear rubber-soled athletic shoes. You will need the appropriate clothes for exercise that allow you to move freely.

## **Stretching**

Stretch before starting your exercise session. Warm muscles respond better to exercises.

- Achilles Tendon and Calf - With both hands against a wall, place one foot behind you. Lean in toward the wall while keeping the rear leg straight and your heel on the ground. Repeat for the other leg.
- Quadriceps - Put your left hand on a wall or table for balance. Reach your right hand behind your back and grasp your right ankle, pull it gently toward your buttocks until you feel tension along the front of your thigh. Repeat on the other side.
- Hamstring - Stand on one leg and prop the other leg parallel to the ground on a stable cabinet or table top. Slide both hands toward the propped-up ankle as far as is comfortable. Repeat on other side.

# Features and Use

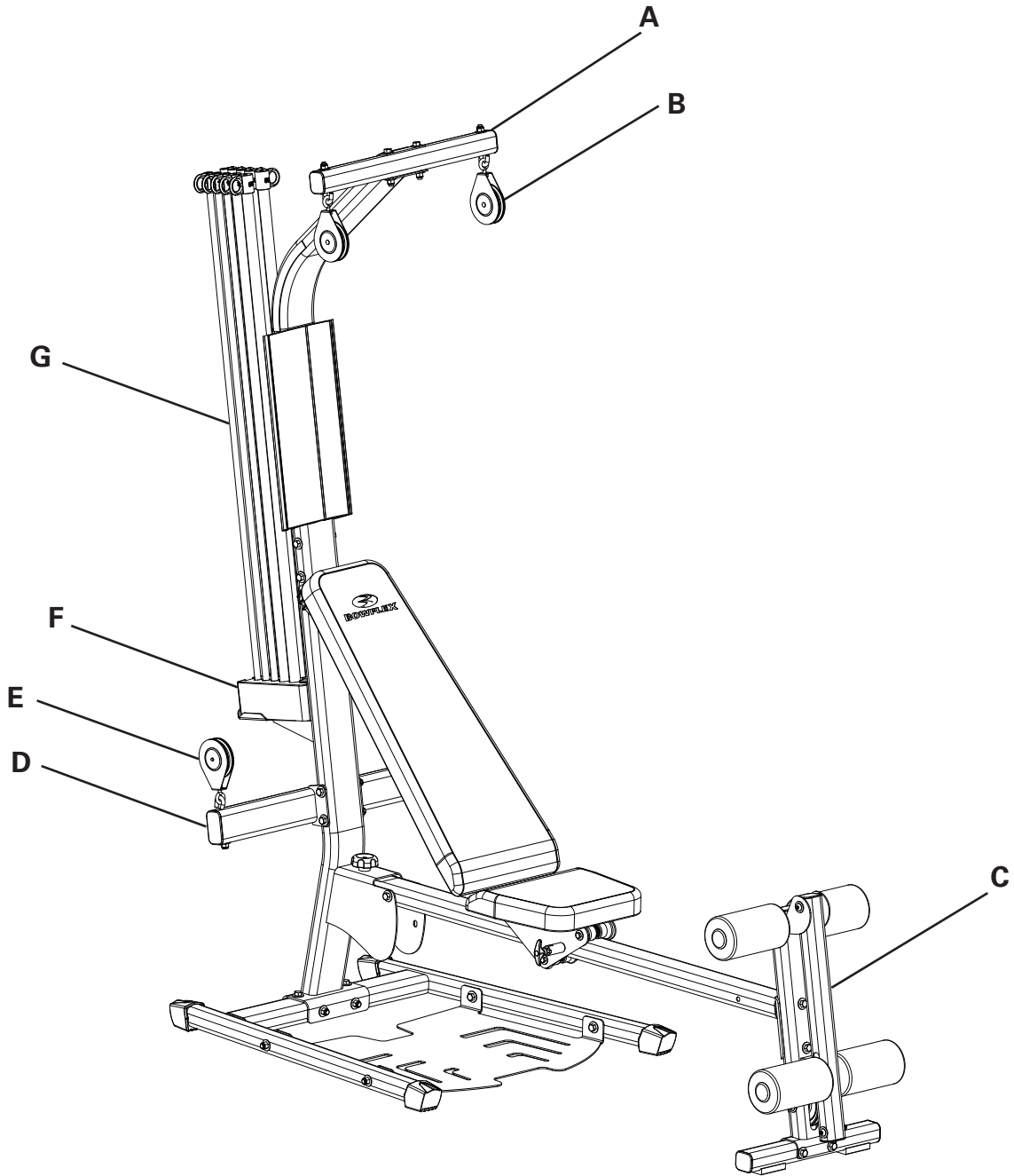

A	Top Cross Bar	E	Chest Bar Pully
B	Top Cross Bar Pully	F	Rod Box
C	Leg Attachment	G	Power Rod® Unit
D	Chest Pully Cross Bar		

# Features and Use

## Power Rod® Resistance

Power Rod® units are made from a special composite material. The rods are sheathed with a protective black rubber coating. Each rod is marked with its weight rating on the "Rod Cap".

## Adjusting and Understanding the Resistance

The Bowflex® PR1000 home gym comes with 210 lbs. (95kg) of nominal resistance [one pair of 5 lb. (2.25kg) rods, two pair of 10 lb. (4.5kg) rods, one pair of 30 lb. (13.5kg) rods, and one pair of 50 lb. (22.5kg) rods].

**Note:** Power Rod® Resistance Rods are manufactured using nylon composite material. The weight resistance measurements are estimates and resistance can vary based on environmental and usage patterns and other factors. Rod resistance will normally degrade over time and after extensive usage. If you have any questions regarding the resistance of your Power Rod® Resistance Rods, contact our Bowflex® Customer Service department for assistance.

## Connecting the Power Rod® Unit to the Cables

You may use one rod or several rods in combination, to create your desired resistance level.

To hook multiple rods up to one cable, bend the closest rod toward the cable and place the cable hook through that rod cap. You can then hook up the next closest rod through the same cable hook.

Hooking up the closest rod first prevents rods from crossing over the top of one another.

## Safety

**!** When you attach the Power Rod® units do not stand directly looking above the top of the rods. Stay off to the side while you attach the rods.

## When You Are Not Using Your Home Gym

Disconnect the cables from the Power Rod® unit when you are not using your home gym. Use the rod binding strap included with your machine to bind all the rods together at the top. You can also place your cables and grips through the strap to keep them out of the way. Leaving the rods and cables under tension could cause injury if a rod were inadvertently released.

**!** Keep the cables and Power Rod® units bound with the rod binding strap when not in operation, and be sure and remove the binding strap before beginning any exercises using the rods.

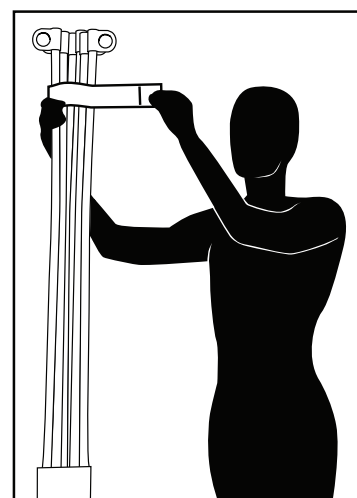
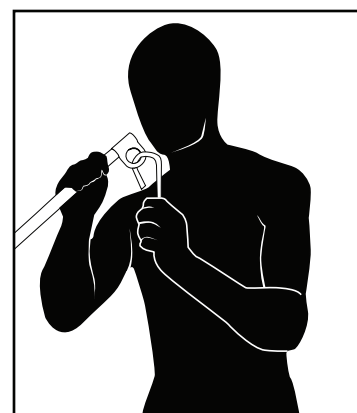
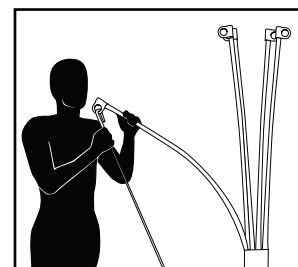
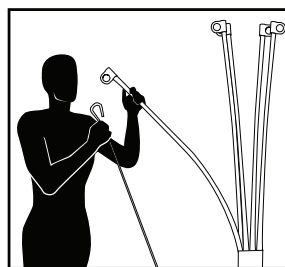
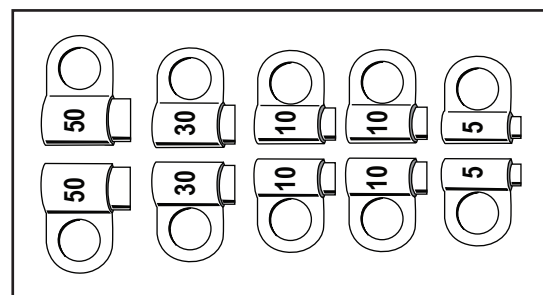



# Features and Use

## The Workout Bench

Your Bowflex® home gym has a number of seat and bench positions: Flat bench, 45° incline and free-sliding seat extension. To adjust the seat, pull out the Seat Rail Knob, then slide the seat to one of the two locking holes on the Seat Rail. Release the Seat Rail Knob to secure the seat.

 Do not make any adjustments to the seat while sitting on it. Do not stand on the seat.

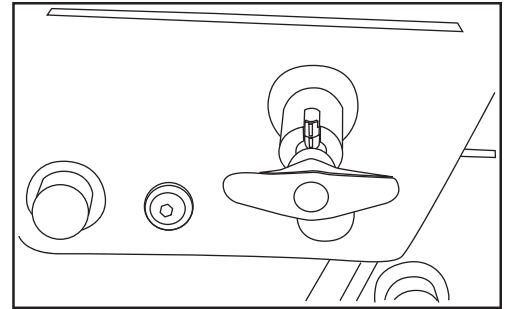

## Removing the Bench

The Bench easily attaches and releases from the Seat. To attach the Bench, insert the half hinge on the end of the Bench into the half hinge on the seat. To remove the Bench, lift up on the long portion of the seat and pull it away from seat rail.

## Flat Bench

The Flat bench position is used for most of the exercises.

## 45° Incline Bench

Start with a flat bench, following the above instructions to release and move the seat and bench. Lift the bench while you slide the seat toward the Power Rod® unit until the bench back rests against the Lat Tower.

## Free-Sliding Seat

Remove the Bench, pull out the Seat Rail Knob, twist it a half turn and release it to put the Seat in a “free sliding” position for Calf Raise or Leg Press exercises.

## Maintenance and Care of Your Bowflex® Home Gym

Inspect your machine for any worn or loose components prior to use. Tighten or replace any worn or loose components prior to use. Pay close attention to cables, or belts and their connections.

 The safety and integrity designed into a machine can only be maintained when the equipment is regularly examined for damage and repaired. It is the sole responsibility of the owner to ensure that regular maintenance is performed. Worn or damaged components should be replaced immediately or the equipment removed from service until the repair is made. Only manufacturer supplied components should be used to maintain/repair the equipment.

 This product, its packaging, and components contain chemicals known to the State of California to cause cancer, birth defects, or reproductive harm. This Notice is provided in accordance with California’s Proposition 65. If you would like additional information, please refer to our Web site at [www.nautilus.com/prop65](http://www.nautilus.com/prop65).

Clean the bench with a non-abrasive household cleaner after each use. Do not use automotive cleaner, which can make the bench too “slick”.

If you have any questions regarding your Bowflex® home gym, please call the Nautilus® Customer Service Department at 1-800-605-3369.

# Features and Use

## Storing Your Home Gym

1. Lock the Seat and Bench into the flat position.
2. Remove all Power Rod® resistance and then bind the Power Rod® unit with the rod binding strap.
3. Remove the Seat Rail Knob from the seat rail.
4. Tilt the bench toward the Power Rod® unit.
5. Secure the bench by inserting the Seat Rail Knob into the hole in the side of the Seat Rail Bracket.

 Failure to attach the Seat Rail Securing Device into the seat rail can cause injury.

Do not stand on the base below the Seat Rail when you lift or lower it. This can cause injury.

Always use two hands to lift and lower the Seat Rail. Bend at the knees when you lift or lower the Seat Rail. Failure to use correct lifting procedure can cause injury.

Do not try to exercise when the seat rail is in the folded position.

Do not move the machine without aid. Injury to you or damage to the machine can occur.

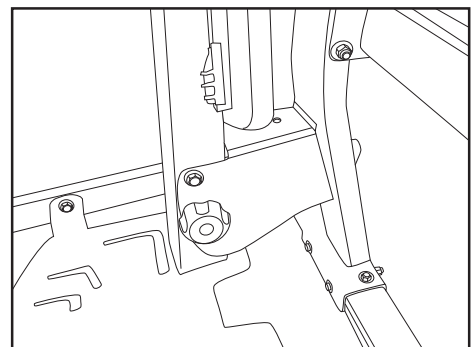
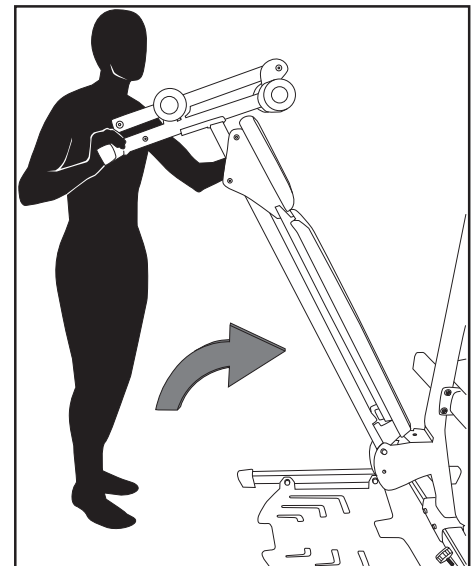
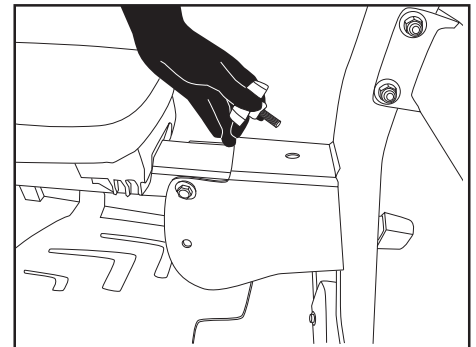
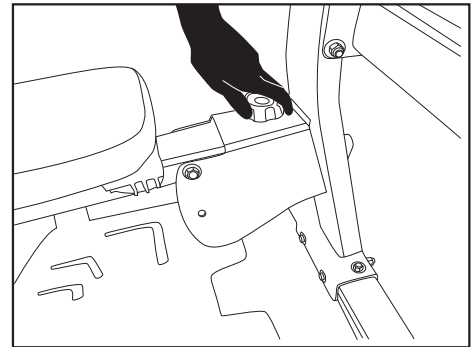

# Features and Use

## Accessories and Equipment

 Always inspect for wear prior to use.

### Handgrips

After fitting the handgrips firmly to your hand, ankle, or wrist, attach the pulley cable clips to the D-rings on the handgrips to attach them to the cables.

**Standard Grip:** Grasp the grip and cuff together to form a grip without inserting your hand through the cuff portion. Most of the exercises you perform utilize this grip. The Standard Grip also is used for Hammer Grip exercises, when you need to hold the handgrip vertically for greater wrist support.

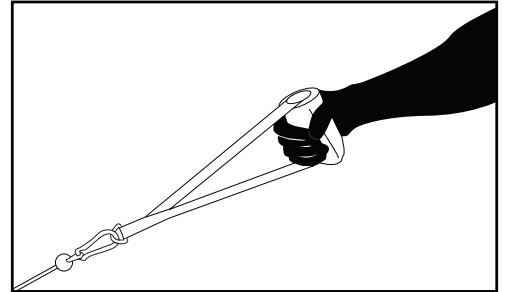

**Hand Cuff Grip:** Slip your hand through the cuff portion of the grip so that the foam pad rests on the back of your hand. Then grasp the remainder of the grip that is sitting in your palm. This method of gripping is great for exercises like front shoulder raises or any exercise where your palm is facing down.

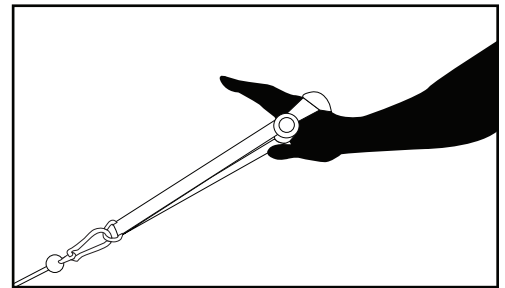

**Foot Grip:** Slip your foot through the cuff of the handle and slide the foam grip against the top of your foot.

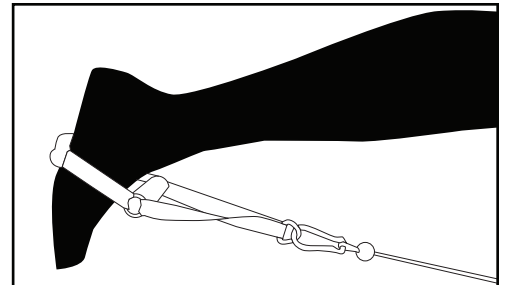

### Leg Press Belt

Wear the Leg Press Belt around your lower arch of spine and attach the D-rings to cable clips. Belt must remain in slight tension to not fall from arch during exercise.



### Additional Accessories

For additional accessories for your home gym, contact Nautilus at 1-800-NAUTILUS (1-800-628-8458) or [www.bowflex.com](http://www.bowflex.com).

# Workouts

## Define Your Goals

It is important to define your goals before you begin your workout routine. The following fitness guidelines will help you define your goals and choose your fitness program.

**Muscle Strength** is the maximum force that you can exert against resistance at one time. Your muscle strength comes into play when you pick up a heavy bag of groceries or lift a small child. It is developed when a localized muscle is worked both positively (concentric) and negatively (eccentric) at a resistance—great enough so you can perform only five to eight repetitions of the exercise before the muscle fails. Each set of repetitions is followed by a rest interval that typically runs three times longer than the set. Later, between exercise sessions, the muscle overcompensates for the stress and usually increases in both strength and size.

**Muscle Endurance** is the ability to perform repeated contractions. It comes into play when you cross-country ski or work on your feet all day. Endurance training addresses the slow twitch, endurance muscle fibers, which depend on oxygen for energy. To develop muscle endurance, use low resistance and high repetitions about 15-20 repetitions in each set, three sets to each exercise, working the muscle only to fatigue.

**Muscle Power** is the combination of strength and speed of the muscular contraction. This is often misinterpreted as; a) being directly associated with certain skill or sport and/or; b) meaning that you must move fast. Load is actually a more important factor than speed when attempting to improve power. When training to achieve muscular power, pick a resistance that fatigues you in the 3-5 repetition range. When performing these reps, it is more important to think of contracting the muscles faster rather than attempting to move faster. Performing sport simulation exercises usually results in a deterioration of the motor pattern or skill. The biomechanically sound method of improving power in your sport is to train for power using the correct joint movements, as described in this manual. Then practice the skill associated with your sport, learning to apply this newly achieved power.

**Body Composition** is the ratio of fat weight (fat) to lean weight (muscles, bones and tissue). As you age, the ratio shifts. The fat weight increases and the lean weight decreases. Training for muscle strength will generally increase muscle size and aerobic conditioning will help burn extra calories. Performing these two forms of

exercise, either at different times or together, will create the greatest changes in body fat weight. Balanced Strength and alignment are the result of equal strength developed in all parts of the body. It comes into play in your standing and sitting posture, and in your ability to perform just about any activity safely and effectively. An over-development of the back will round the shoulders; weak or stretched abdominals can cause lower back pain. You want a balance of muscle strength in front and back. In addition, you need a balance of strength between your middle, lower, and upper body.

**Flexibility** is the ability of a muscle or group of muscles to move the joint through a full range of motion. Flexibility comes into play when you execute an overhand serve or stretch for the top shelf in the kitchen. It is a cooperative movement of opposite muscle groups. When a muscle contracts, its opposite muscle group must relax for the action to occur. Increased flexibility means an increased range of motion, made possibly by this simultaneous contracting and relaxing. Good flexibility is important in protecting the body from injury and can be achieved through the balanced strength training programs that are included in this manual.

**Cardiovascular Endurance** is the ability of the heart and lungs to supply oxygen and nutrients to exercising muscles over an extended period of time. It comes into play when you jog a mile or ride a bike. It is a critical component of overall fitness and health.

# Workouts

## Design Your Own Program

You may want to design your own personal program specifically geared to your goals and lifestyle. Designing a program is easy by following the guidelines below.

### Understand fitness and its components

Improperly designed programs can be dangerous. Take some time to review this manual as well as other fitness guides.

### Know your current fitness level

Before you start any fitness program you should consult a physician who will help you determine your current abilities.

### Identify your goals

Goals are critical to choosing and designing an exercise program that fits and enhances your lifestyle, but so is strategy. It's important not to rush the process and try to accomplish too much too soon. That will lead to setbacks and discouragement. Instead, set a series of smaller achievable goals.

### Select complementary exercises

Be sure to pair exercises that address compound joint movements and single joint movements. In addition, select exercises that address complementary muscle groups.

### Put first things first

During each session, first work muscle groups that need the most training.

### Remember your cardiovascular component

Any fitness program must contain a cardiovascular fitness component to be complete. So complement your resistance training with aerobic exercise such as walking, running, or bicycling.

### Training variables

When designing your own program there are several variables that, when mixed properly, will equal the right fitness formula for you. In order to find out the best formula, you must experiment with several combinations of variables.

### The variables are as follows

- **Training Frequency:** The number of times you train per week. We recommend daily activity but not daily training of the same muscle group.
- **Training Intensity:** The amount of resistance used during your repetition.
- **Training Volume:** The number of repetitions and sets performed.

- **Rest Intervals:** The time you rest between sets and the time you rest between workouts.

### Once you've established a base of fitness, follow these basic principles

- **Isolate Muscle Groups:** Focus work on specific muscle groups.
- **Progressive Loading:** The gradual systematic increase of repetitions, resistance and exercise period.

### Working Out

A good pre-workout mental routine is to sit and relax, so that you can focus on what you are about to do and think about achieving your end goal.

### Warming Up

We recommend that you warm up by doing light stretching and performing light exercises on the Bowflex® home gym.

### Cooling Down

An essential part of the exercise routine is the cool down. Gradually reduce the level of exercise intensity so that blood does not accumulate in one muscle group, but continues to circulate at a decreasing rate. Remember to gradually move yourself into a relaxed state.

### Breathing

Breathing in or out during the actual performance is not dependent upon the direction of air flow relative to exertion. It is, in fact, a mechanical process that changes the position of your spine as your rib cage moves. Here are some tips for breathing:

1. Be cautious when you are concentrating or exerting effort. This is when you will probably hold your breath. Do not hold your breath. Do not exaggerate breathing. Depth of inhalation and exhalation should be natural for the situation.
2. Allow breathing to occur naturally, do not force it.

# Workouts

## Workouts

### 20 Minute Better Body Workout

**Frequency:** 3 days per week (M-W-F)

**Time:** 20 minutes

Start by performing one set of each exercise. Warm up with a light resistance that you can perform easily for 5–10 reps without fatigue. Focus on practicing and learning your technique before increasing the resistance. Then move to a more challenging resistance that you can perform no less than 10 reps and no more than 15 reps. As you become stronger, you can advance to two sets for each exercise. Complete all sets of each exercise before moving on to the next one. Rest 30 to 45 seconds between sets. Move slowly on each rep. Use a pace that would allow you to stop the movement instantly at any point in the rep. Count three seconds up and three seconds down and work to fatigue during each set.

Body Part	Exercise	Sets	Reps
Chest	Bench Press	1-2	10-15
Back	Seated Lat Rows	1-2	10-15
Shoulders	Crossover Seated Rear Deltoid Rows	1-2	10-15
Arms	Standing Biceps Curl	1-2	10-15
	Triceps Pushdown	1-2	10-15
Legs	Calf Raise	1-2	10-15
	Leg Press	1-2	10-15
Trunk	Trunk Rotation	1-2	10-15
	Seated Abdominal Crunch	1-2	10-15

### Advanced General Conditioning

**Frequency:** 4 days per week (M-T-Th-F)

**Time:** 20 minutes

When you are proficient in performing the exercise techniques of the above workout and are no longer realizing results, or have become just plain bored, it is time to change your program. You can increase your training with this "split system" routine that works opposing muscle groups on different days. To do this, you will increase your resistance when you can perform 12 reps perfectly, and you will increase your volume by performing more sets and more exercises. Move slowly on each rep. Use a pace that would allow you to stop the movement instantly at any point in the rep. Count three seconds up and three seconds down and work to fatigue during each set.

#### Days 1 & 3

Body Part	Exercise	Sets	Reps
Chest	Bench Press	1-3	10-12
Shoulders	Seated Shoulder Press	1-3	10-12
Arms	Triceps Pushdown	1-3	10-12
	Standing Biceps Curl	1-3	10-12
Legs	Leg Extension	1-3	10-12
	Calf Raise	1-3	10-12

# Workouts

Days 2 & 4	Body Part	Exercise	Sets	Reps
	Back	Seated Lat Rows	1-3	10-12
		Stiff Arm Pulldowns	1-3	10-12
	Shoulders	Crossover Seated Rear Deltoid Row	1-3	10-12
	Arms	Standing Biceps Curl	1-3	10-12
		Triceps Pushdown	1-3	10-12
	Trunk	Trunk Rotation	1-3	10-12
		Seated Abdominal Crunch	1-3	10-12

## 20 Minute Upper/Lower Body

**Frequency:** 4 days per week (M-T-Th-F)

**Time:** 20 minutes

This program provides a quick and effective workout that combines muscle conditioning with some cardiovascular benefits. Perform this routine when you are limited in time or just want a variation to your normal routine. Perform this program training 2 days, resting 1 to 2. Perform all exercises to near failure, stopping at the point that your technique starts to deteriorate. Rest only 20-30 seconds between sets. As you get stronger, increase the number of sets you perform. Move slowly on each rep. Use a pace that would allow you to stop the movement instantly at any point in the rep. Count three seconds up and three seconds down.

Days 1 & 3	Body Part	Exercise	Sets	Reps
	Chest	Bench Press	1-3	12-15
	Back	Seated Lat Rows	1-3	12-15
	Shoulders	Crossover Seated Rear Deltoid Rows	1-3	12-15
	Arms	Standing Biceps Curl	1-3	12-15
		Lying Triceps Extension	1-3	12-15

Days 2 & 4	Body Part	Exercise	Sets	Reps
	Legs	Leg Extension	1-3	12-15
		Leg Press	1-3	12-15
		Standing Leg Kickback	1-3	12-15
		Standing Hip Adduction	1-3	12-15
	Trunk	Trunk Rotation	1-3	10-12
		Seated Abdominal Crunch	1-3	10-12

# Workouts

## Body Building

**Frequency:** 6 days on, 1 day off (Day 6)

**Time:** 45-60 minutes

Body building requires focused concentration and dedication to training, as well as proper eating habits. Work each muscle group to fatigue before moving on to the next exercise. Do not neglect any muscle group. If needed, include an aerobic activity to increase your caloric expenditure and help to reduce your body fat levels to achieve a defined muscular look. Rest 30-60 seconds between each set and exercise. Focus on proper form. Tighten the muscle before you move, squeeze the muscle as you move, cramp the muscle at the point of full contraction, and resist the movement as you lower the weight. Move slowly on each rep. Use a pace that would allow you to stop the movement instantly at any point in the rep. Count three seconds up and three seconds down and work to fatigue during each set.

Days 1 & 3	Body Part	Exercise	Sets	Reps
	Chest	Bench Press	2-4	8-12
		Decline Bench Press	2-4	8-12
	Shoulders	Seated Shoulder Press	2-4	8-12
		Crossover Seated Rear Deltoid Rows	2-4	8-12
		Front Shoulder Raise	2-4	8-12
		Scapular Retraction	2-4	8-12

Days 2 & 4	Body Part	Exercise	Sets	Reps
	Back	Seated Lat Rows	2-4	8-12
		Reverse Grip Pulldowns	2-4	8-12
	Arms	Standing Biceps Curl	2-4	8-12
		Standing Wrist Curl	2-4	8-12
		Triceps Pushdown	2-4	8-12
		Lying Triceps Extension	2-4	8-12

Days 5 & 7	Body Part	Exercise	Sets	Reps
	Legs	Leg Press	2-4	8-12
		Leg Extension	2-4	8-12
		Standing Leg Kickback	2-4	8-12
		Seated Hip Abduction	2-4	8-12
	Trunk	Seated Abdominal Crunch	2-4	8-12
		Trunk Rotation	2-4	8-12



# Workouts

## Circuit Training - Anaerobic/Cardiovascular

**Frequency:** 6 days on, 1 day off (Day 6)

**Time:** 20-45 minutes

Circuit training is a great way to achieve the benefits of strength training and cardiovascular training in one quick, challenging routine. The idea is to move quickly from exercise to exercise, taking only as much rest between sets as it takes to set up the next exercise (less than 20 seconds). One circuit equals one set of each exercise. Initially, start with completing one round of Circuit 1. Then add an additional round of the same circuit. Once you reach three rounds of Circuit 1, add one round of Circuit 2. Add additional rounds of Circuit 2 as your fitness level increases. Repeat the process with Circuit 3. Do not let your heart rate exceed 220, minus your resting heart rate. Perform each rep of each exercise slowly. Count three seconds up and three seconds down.

<b>Days 1 &amp; 3</b>	<b>Body Part</b>	<b>Exercise</b>	<b>Reps</b>
	Chest	Bench Press	8-12
	Legs	Leg Press	8-12
	Back	Seated Lat Rows	8-12
	Legs	Calf Raise	8-12
	Trunk	Seated Abdominal Crunch	8-12

<b>Days 2 &amp; 4</b>	<b>Body Part</b>	<b>Exercise</b>	<b>Reps</b>
	Shoulders	Seated Shoulder Press	8-12
	Legs	Leg Extension	8-12
	Back	Narrow Pulldowns	8-12
	Trunk	Seated Abdominal Crunch	8-12
	Arms	Standing Biceps Curl	8-12

<b>Days 5 &amp; 7</b>	<b>Body Part</b>	<b>Exercise</b>	<b>Reps</b>
	Shoulders	Crossover Seated Rear Deltoid Rows	8-12
	Arms	Triceps Pushdown	8-12
	Legs	Calf Raise	8-12
	Trunk	Trunk Rotation	8-12

# Workouts

## True Aerobic Circuit Training

**Frequency:** 2-3 times per week

**Time:** 20-60 minutes

Circuit training is a great way to achieve the benefits of strength training and cardiovascular training in one quick, challenging routine. By returning to an aerobic exercise between each set you are increasing your aerobic capacity, endurance and burning fat as energy. The idea is to move quickly from exercise to exercise, taking only as much rest between sets as it takes to set up the next exercise (less than 20 seconds). One circuit equals one set of each exercise. Initially, start with completing one round of Circuit 1. Then add an additional round of the same circuit. Once you reach three rounds of Circuit 1, add one round of Circuit 2. Add additional rounds of Circuit 2 as your fitness level increases. Do not let your heart rate exceed 220 minus your resting heart rate. Perform each rep of each exercise slowly and with perfect technique. Count three seconds up and three seconds down.

Any type of aerobic exercise can be used for this routine. Some examples are: jumping jacks, jogging in place, or stair climbing.

<b>Circuit 1</b>	<b>Body Part</b>	<b>Exercise</b>	<b>Reps</b>
	Chest	Bench Press	8-12
	Aerobic Exercise	30-60 Seconds	
	Legs	Leg Press	8-12
	Aerobic Exercise	30-60 Seconds	
	Back	Seated Lat Rows	8-12
	Aerobic Exercise	30-60 Seconds	
	Legs	Calf Raise	8-12
	Aerobic Exercise	30-60 Seconds	
	Trunk	Seated Abdominal Crunch	8-12
	Aerobic Exercise	30-60 Seconds	

<b>Circuit 2</b>	<b>Body Part</b>	<b>Exercise</b>	<b>Reps</b>
	Shoulders	Seated Shoulder Press	8-12
	Aerobic Exercise	30-60 Seconds	
	Legs	Leg Extension	8-12
	Aerobic Exercise	30-60 Seconds	
	Back	Reverse Grip Pulldown	8-12
	Aerobic Exercise	30-60 Seconds	
	Trunk	Trunk Rotation	8-12
	Aerobic Exercise	30-60 Seconds	
	Arms	Standing Biceps Curl	8-12

# Workouts

## Strength Training

**Frequency:** 3 days per week (M-W-F)

**Time:** 45-60 minutes

This program is designed to emphasize overall strength development. This is an advanced routine to be used only after you have progressed from the advanced general conditioning routine and only after you have perfected your exercise techniques. Work each set to near exhaustion. If you can perform more than 5 to 8 reps, you should increase your resistance 5 lbs and decrease your reps to 5. Rest 60–120 seconds between each set and exercise. Focus on proper form. Tighten the muscle before you move, squeeze the muscle as you move, cramp the muscle at the point of full contraction, and resist the movement as you lower the weight. Move slowly on each rep. Use a pace that would allow you to stop the movement instantly at any point in the rep. Count two seconds up and four seconds down and work to fatigue during each set.

### Day 1

Body Part	Exercise	Sets	Reps
Chest	Bench Press	2-4	5-8
	Decline Bench Press	2-4	5-8
Shoulders	Seated Shoulder Press	2-4	5-8
	Crossover Seated Rear Deltoid Rows	2-4	5-8
	Front Shoulder Raise	2-4	5-8

### Day 2

Body Part	Exercise	Sets	Reps
Back	Seated Lat Rows	2-4	5-8
	Stiff Arm Pulldowns	2-4	5-8
Arms	Standing Biceps Curl	2-4	5-8
	Standing Wrist Curl	2-4	5-8
	Triceps Pushdown	2-4	5-8
	Triceps Extension	2-4	5-8

### Day 3

Body Part	Exercise	Sets	Reps
Legs	Leg Press	2-4	5-8
	Leg Extension	2-4	5-8
	Standing Leg Kickback	2-4	5-8
	Calf Raise	2-4	5-8
Trunk	Trunk Rotation	2-4	5-8
	Seated Abdominal Crunch	2-4	5-8

# Exercises



Keep your body weight centered on the machine, seat or base frame platform while exercising.

When using the machine for standing leg exercises, always hold the Lat Tower of the machine for stability.

All exercises in this manual are based on the calibrated resistance and capacity levels of this machine. Only exercises included in this manual or in written materials authorized and supplied by Bowflex® are recommended for operation with this machine.

## Aerobic Rowing

### Muscles worked

Pectoralis Major; Anterior Deltoids

### Machine Set-Up

- Remove bench and seat rail knob
- Chest Bar pulleys
- Hand Grips
- Attach the clips to the resistance rods

### Success Tips

- Maintain good spinal alignment. Keep chest lifted.
- Bend from the hip during movement, not from the waist.

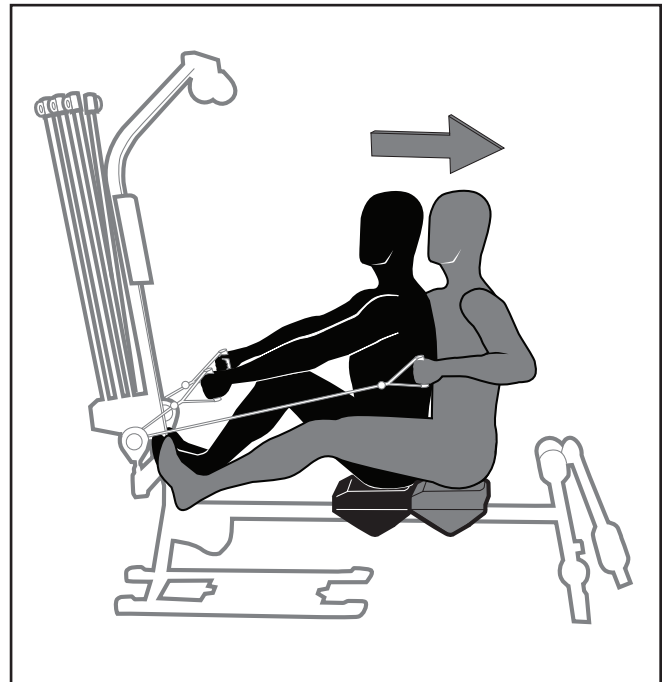

# Exercises

## Chest Exercises

### Bench Press - Shoulder Horizontal Adduction (and elbow extension)

#### Muscles Worked

Pectoralis Major, Deltoids, Triceps

#### Machine Set-Up

- Adjust the bench to a 45° incline.
- Chest Bar pulleys
- Handgrips
- Attach the clips to the Power Rod® resistance rods.

#### Success Tips

- Maintain a 90° angle between your upper arms and your torso throughout the motion.
- Keep your chest muscles tight.
- Limit and control your range of motion.
- Keep your knees bent, feet flat on the floor, head back against the bench.
- Keep your shoulder blades pinched together and maintain good spinal alignment.

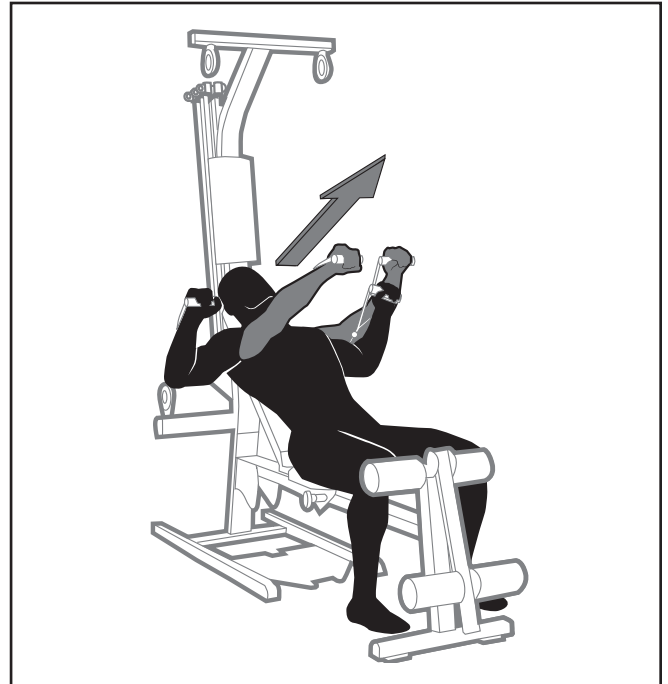

### Decline Bench Press - Shoulder Horizontal Adduction (and elbow extension)

#### Muscles Worked

Pectoralis Major, Deltoids, Triceps

#### Machine Set-Up

- Adjust the bench to a 45° incline.
- Chest Bar pulleys
- Handgrips
- Attach the clips to the Power Rod® resistance rods.

#### Success Tips

- Maintain a 90° angle between your upper arms and torso at the start of the motion, and slightly less than 90° at the finish.
- Keep your knees bent, feet flat on the floor, head back against the bench.
- Do not let your elbows travel behind your shoulders.
- Keep your shoulder blades pinched together and maintain good spinal alignment.

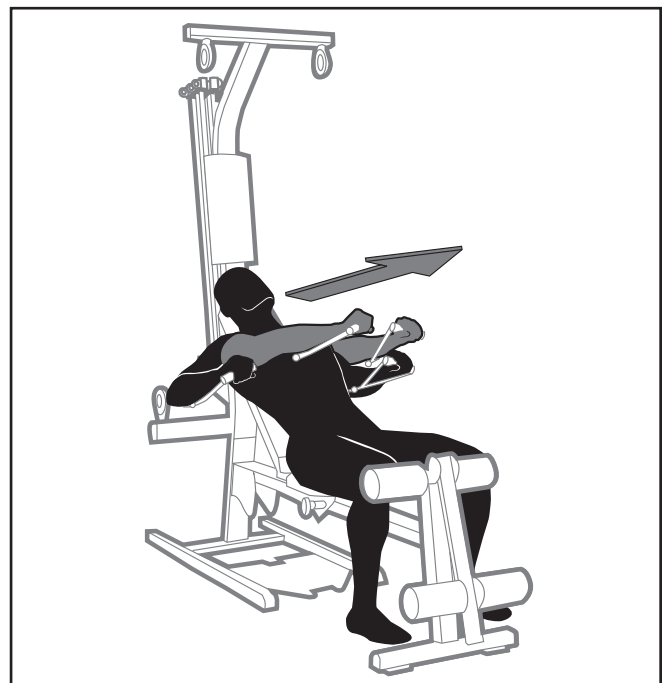

# Exercises

## Chest Exercises

### Incline Bench Press - Shoulder Horizontal Adduction (and elbow extension)

#### Muscles Worked

Pectoralis Major, Deltoids, Triceps

#### Machine Set-Up

- Adjust the bench to a 45° incline.
- Chest Bar pulleys
- Handgrips
- Attach the clips to the Power Rod® resistance rods.

#### Success Tips

- Maintain a 90° angle between your upper arms and torso at the start of the motion, and slightly less than 90° at the finish.
- Keep your knees bent, feet flat on the floor, head back against the bench.
- Do not let your elbows travel behind your shoulders.
- Keep your shoulder blades pinched together and maintain good spinal alignment.

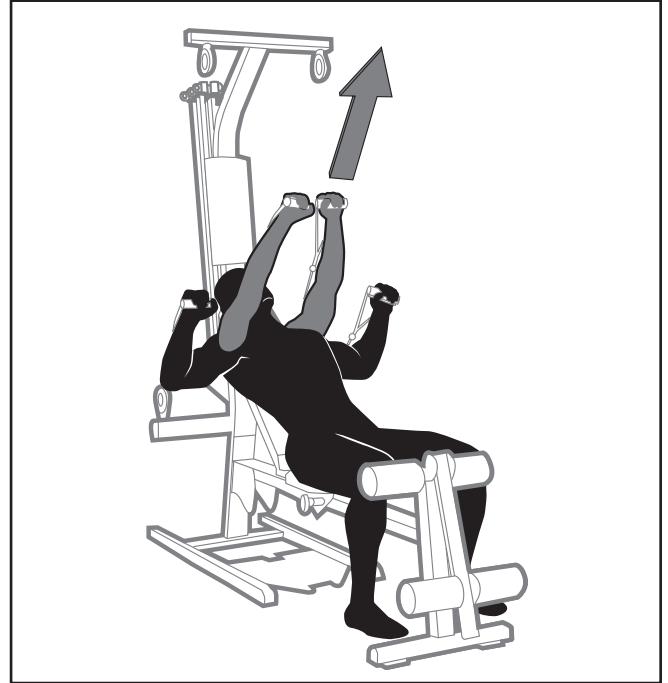

## Shoulder Exercises

### Seated Shoulder Press - Shoulder Adduction (and elbow extension)

#### Muscles Worked

Front Deltoids, Upper Trapezius, Triceps

#### Machine Set-Up

- Adjust to Flat Bench position
- Chest Bar pulleys
- Handgrips
- Attach the clips to the Power Rod® resistance rods

#### Success Tips

- Keep your knees bent and your feet flat on the floor.
- Do not increase the arch in your lower back as you raise your arms, but keep your spine steady and tight.
- Keep your abdominals tight and maintain good spinal alignment.
- Keep tension in your front shoulder muscles when you return to the starting position.

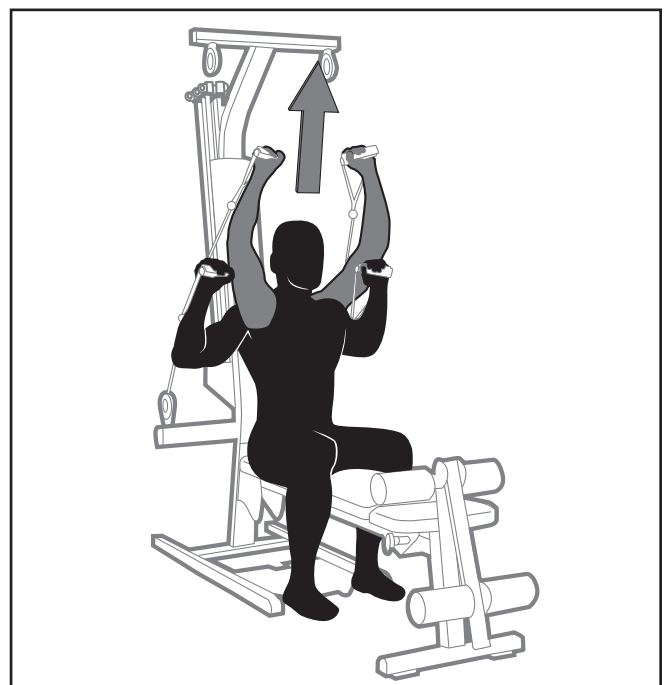

# Exercises

## Shoulder Exercises

### Front Shoulder Raise - Shoulder Flexion (elbow stabilized)

#### Muscles Worked

Front and Middle Deltoids

#### Machine Set-Up

- Adjust to Flat Bench position.
- Chest Bar pulleys
- Handgrips
- Attach the clips to the Power Rod® resistance rods.

#### Success Tips

- Keep your abdominals tight and maintain good spinal alignment with a slight arch in your lower back.
- Keep your knees bent and your feet flat on the floor.
- Do not increase the arch in your lower back as you raise your arms, but keep your spine steady and tight.
- Your arms may be moved alternately or together.

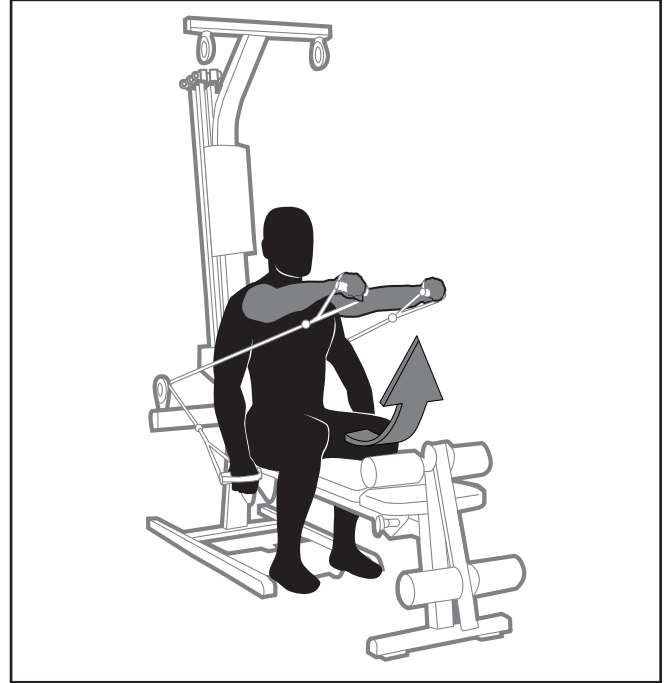

### Crossover Seated Rear Deltoid Rows

#### Muscles Worked

Rear and Middle Deltoids, Posterior, Rotator Cuff, Upper Latissimus, Teres Major, Trapezius, Rhomboids

#### Machine Set-Up

- Adjust to Flat Bench position.
- Chest Bar pulleys
- Handgrips
- Attach the clips to the Power Rod® resistance rods.

#### Success Tips

- Maintain a 90° angle between your upper arms and torso throughout the motion.
- Keep your knees bent and your feet flat on the floor.
- To work one arm at a time place the non-working hand on the bench to stabilize.
- Keep your shoulder blades pinched together and maintain good spinal alignment.

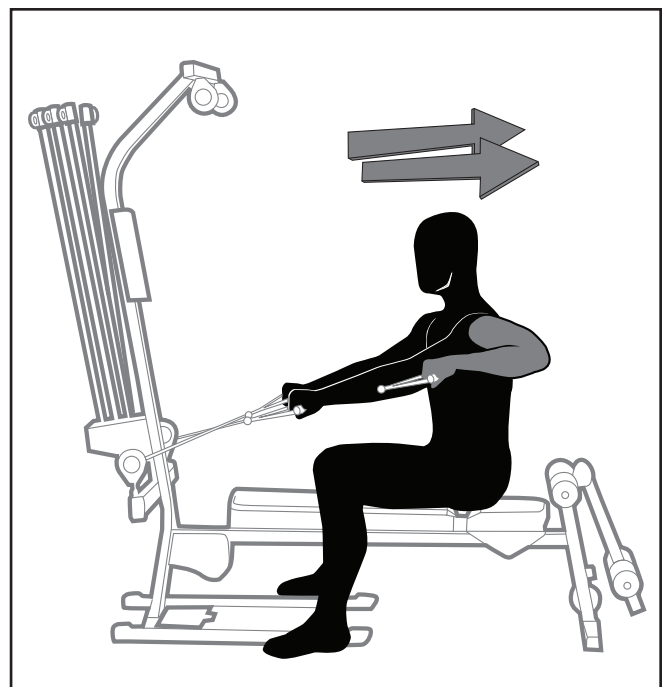

# Exercises

## Shoulder Exercises

### Scapular Retraction

#### Muscles Worked

Middle Trapezius, Rhomboids

#### Machine Set-Up

- Adjust to Flat Bench position.
- Chest Bar pulleys
- Handgrips
- Attach the clips to the Power Rod® resistance rods.

#### Success Tips

- Do not lose your spinal alignment.
- Keep your chest lifted.
- Keep your knees bent and your feet flat on the floor.
- Keep your spine aligned and a slight arch in your lower back.
- Do not use your arm muscles for this movement.

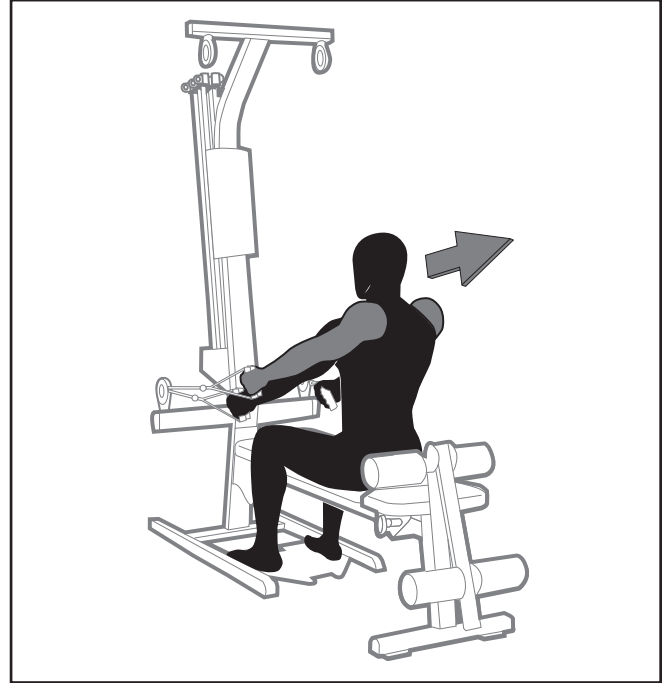

## Back Exercises

### Narrow Pulldowns

#### Muscles Worked

Latissimus Dorsi, Teres Major, Rear Deltoids, Biceps

#### Machine Set-Up

- Adjust to Flat Bench position.
- Top Cross Bar pulleys
- Handgrips
- Attach the clips to the Power Rod® resistance rods.

#### Success Tips

- Keep your knees bent and your feet flat on the floor.
- Keep your spine aligned, abs tight and a slight arch in your lower back.
- Keep your lats tightened throughout the exercise.
- Release your shoulder blades at the top of each rep.
- Initiate each new rep by depressing your shoulder blades.





# Exercises

## Back Exercises

### Stiff Arm Pulldowns

#### Muscles Worked

Latissimus Dorsi, Teres Major, Rear Deltoids, Biceps

#### Machine Set-Up

- Adjust to Flat Bench position.
- Top Cross Bar pulleys
- Handgrips
- Attach the clips to the Power Rod® resistance rods.

#### Success Tips

- Keep your knees slightly bent and your feet flat on the floor.
- Keep your spine aligned, abs tight and a slight arch in your lower back.

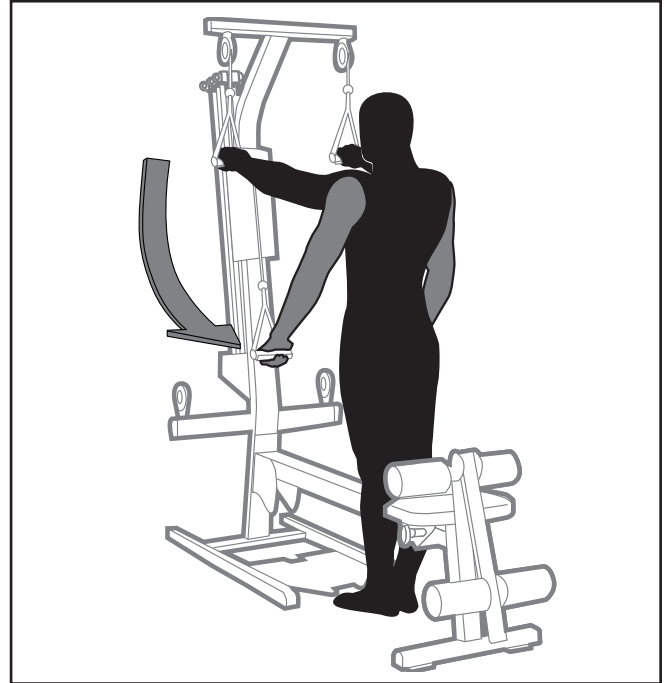

### Seated Lat Rows - Shoulder Extension (and elbow flexion)

#### Muscles Worked

Latissimus Dorsi, Teres Major, Rear Deltoids, Biceps

#### Machine Set-Up

- Adjust to Flat Bench position.
- Chest Bar pulleys
- Handgrips
- Attach the clips to the Power Rod® resistance rods.

#### Success Tips

- Keep your knees bent and your feet flat on the floor.
- Do not bend your torso forward.
- Keep your chest lifted and maintain spinal alignment.
- Release your shoulder blades at the top of each rep.
- Initiate each new rep by depressing your shoulder blades.

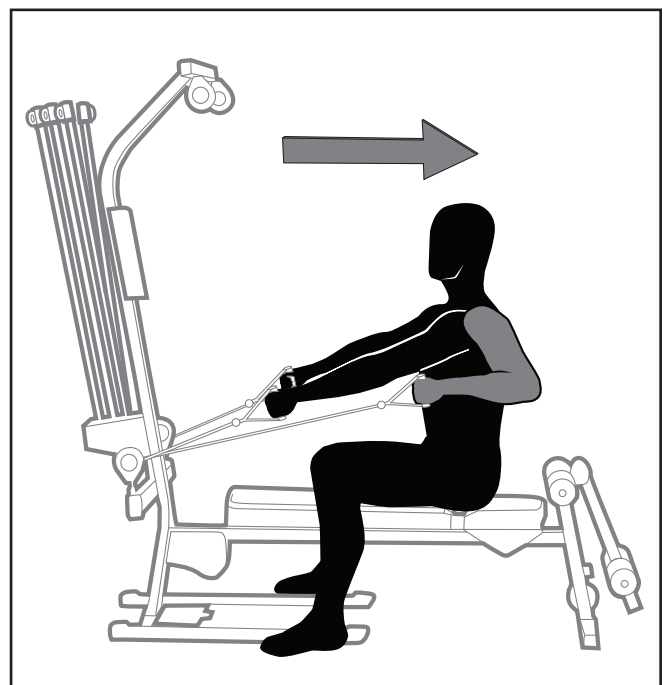

# Exercises

## Back Exercises

### Reverse Grip Pulldown

#### Muscles Worked

Lower Trapezius

#### Machine Set-Up

- Adjust to Flat Bench position.
- Chest Bar pulleys
- Handgrips
- Attach the clips to the Power Rod® resistance rods.

#### Success Tips

- Keep your knees bent and your feet flat on the floor.
- Keep your spine aligned, abs tight and a slight arch in your lower back.
- Keep your lats tightened through this exercise.
- Release your shoulder blades at the top of each rep.
- Initiate each new rep by depressing your shoulder blades.

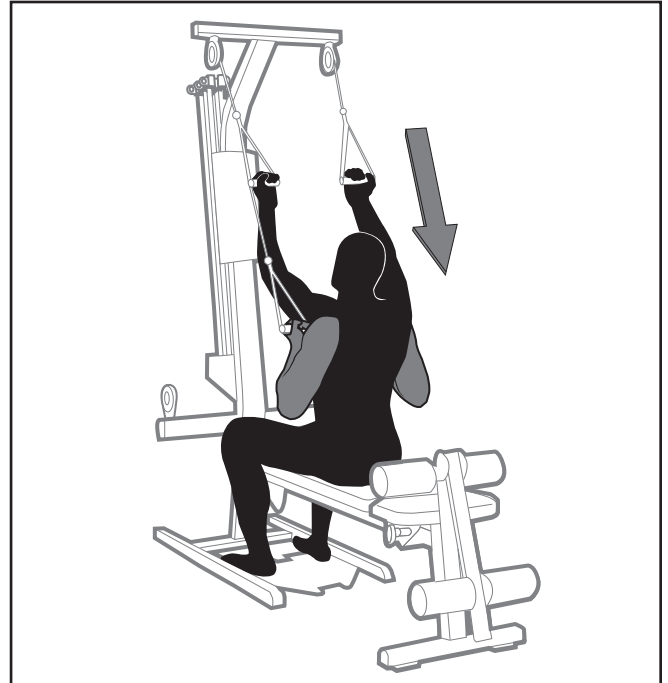

### Seated Low Back Extension

#### Muscles Worked

Lower Trapezios

#### Machine Set-Up

- Adjust to Flat Bench position.
- Chest Bar pulleys
- Handgrips
- Attach the clips to the Power Rod® resistance rods.

#### Success Tips

- Keep your knees bent and your feet flat on the floor.
- Pivot at torso only.
- Keep your chest lifted and maintain spinal alignment.
- Keep arms crossed with hand grips looped onto forearm.
- Release your shoulder blades at the top of each rep.
- Initiate each new rep by depressing your shoulder blades.

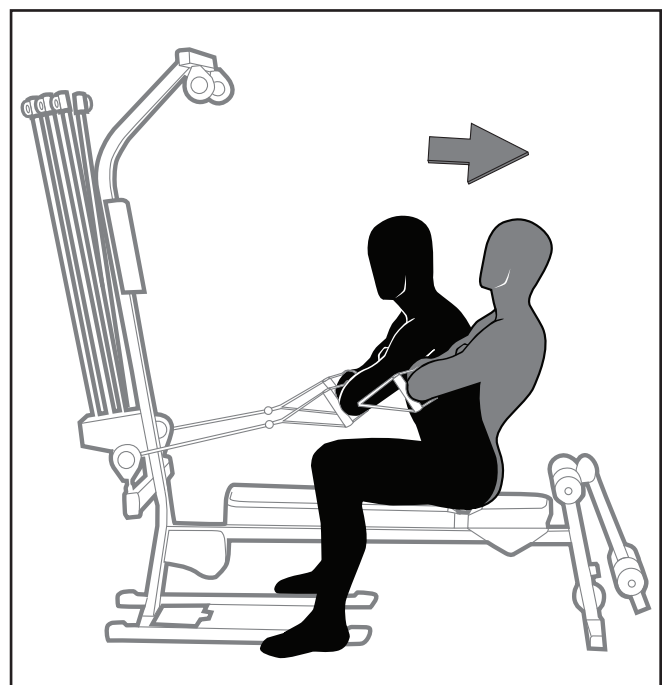

# Exercises

## Arm Exercises

### Triceps Pushdown - Elbow Extension

#### Muscles Worked

Triceps

#### Machine Set-Up

- Remove the bench.
- Top Cross Bar pulleys
- Handgrips
- Attach the clips to the Power Rod® resistance rods.

#### Success Tips

- Keep your upper arms motionless and your wrists straight.
- Keep your chest lifted, abs tight and maintain a slight arch in your lower back.
- Keep your knees slightly bent and your feet flat on the floor.
- Use a controlled motion and tighten your triceps throughout the exercise.

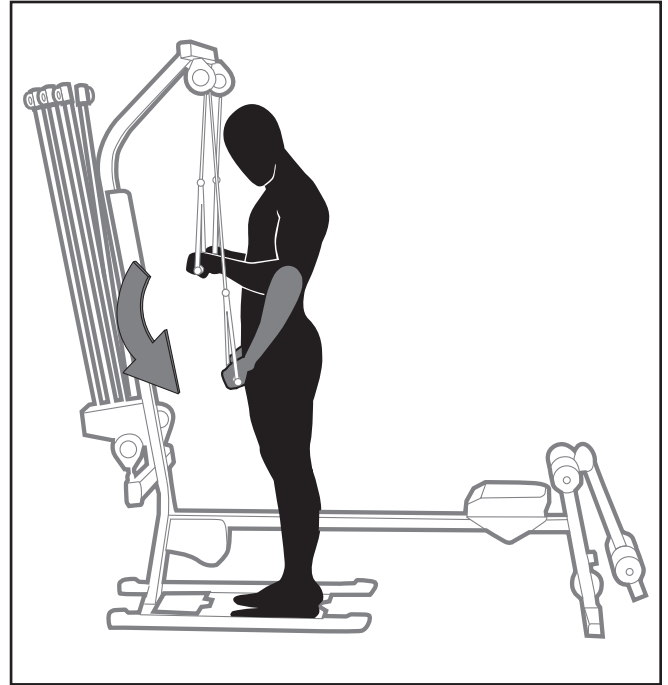

### Lying Triceps Extension - Elbow Extension

#### Muscles Worked

Triceps

#### Machine Set-Up

- Adjust to Flat Bench position.
- Chest Bar pulleys
- Handgrips
- Attach the clips to the Power Rod® resistance rods.

#### Success Tips

- Keep your knees bent and your feet flat on the floor.
- Lay your head back against the bench.
- Keep your chest lifted, shoulders pinched together and a very slight arch in your lower back.
- Keep your upper arms and shoulders motionless and your wrists straight.
- Use a controlled motion and tighten your triceps throughout the exercise.



# Exercises

## Arm Exercises

### Standing Biceps Curl - Elbow Flexion (in supination)

#### Muscles Worked

Biceps

#### Machine Set-Up

- Remove the bench.
- Chest Bar pulleys
- Handgrips
- Attach the clips to the Power Rod® resistance rods.

#### Success Tips

- Keep your chest lifted, abs tight and a very slight arch in your lower back.
- Keep your knees slightly bent and your feet flat on the floor.
- Keep your elbows at your sides and your wrists straight.

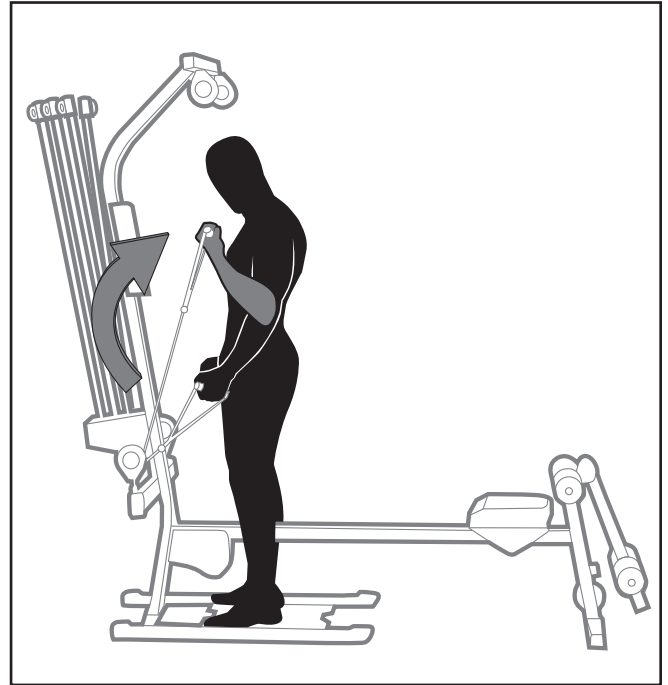

### Standing Wrist Curl

#### Muscles Worked

Biceps, Forearms

#### Machine Set-Up

- Remove the bench
- Chest Bar pulleys
- Handgrips
- Attach the clips to the Power Rod® resistance rods

#### Success Tips

- Keep your chest lifted, trunk muscles tight and a very slight arch in your lower back.
- Move slowly, keeping tension in the front of your forearms at all times.
- Keep your knees slightly bent and your feet flat on the floor.
- Do not increase or decrease the bend in your elbow during this exercise. Keep all motion in the wrist.
- Do not rock your body back and forth during the wrist motion.

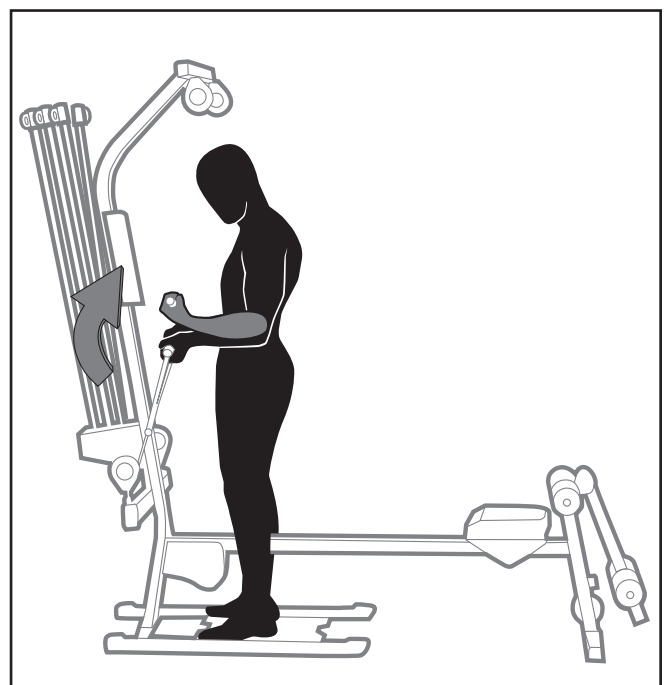

# Exercises

## Abdominal Exercises

### Seated (Resisted) Abdominal Crunch - Spinal Flexion

#### Muscles Worked

Rectus Abdominus, Obliques

#### Machine Set-Up

- Adjust the bench to a 45° incline.
- Chest Bar pulleys
- Handgrips
- Attach the clips to the Power Rod® resistance rods.

#### Success Tips

- Do not lift your head or chin. Your head should follow the rib motion rather than lead it.
- Maintain normal neck posture.
- Tighten your abs throughout the entire exercise and relax only at the end of each set.
- Move slowly to eliminate momentum.
- Exhale during the upward movement and inhale during the downward movement.

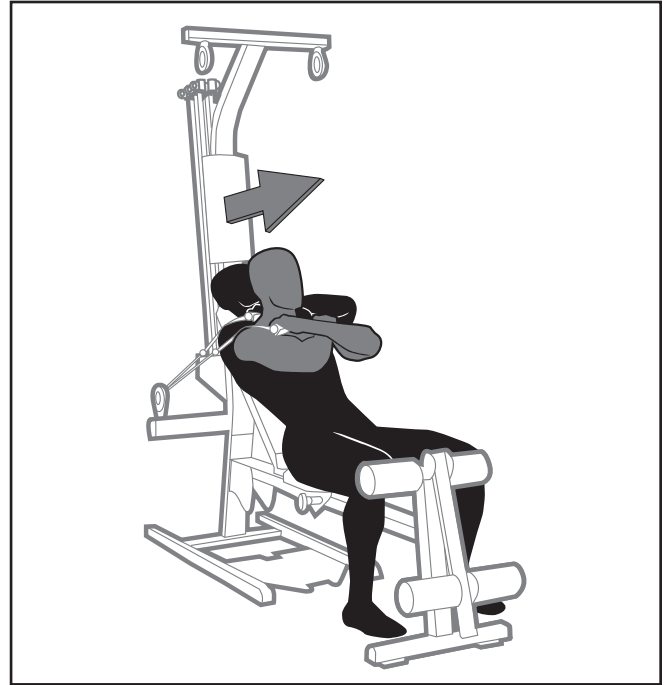

## Trunk Rotation

#### Muscles Worked

Rectus Abdominus, Obliques, Serratus Anterior

#### Machine Set-Up

- Adjust to Flat Bench position.
- Chest Bar pulleys
- Handgrips
- Attach the clips to the Power Rod® resistance rods.

#### Success Tips

- Keep your chest lifted, shoulders pinched, abs tight and a slight arch in your lower back.
- Use only low weight Rods.
- Keep all motion in your torso.
- Move only as far as your muscles let you. Do not use momentum to increase your range of motion.

 Failure to perform this exercise correctly could result in injury. Use only low weight rods.

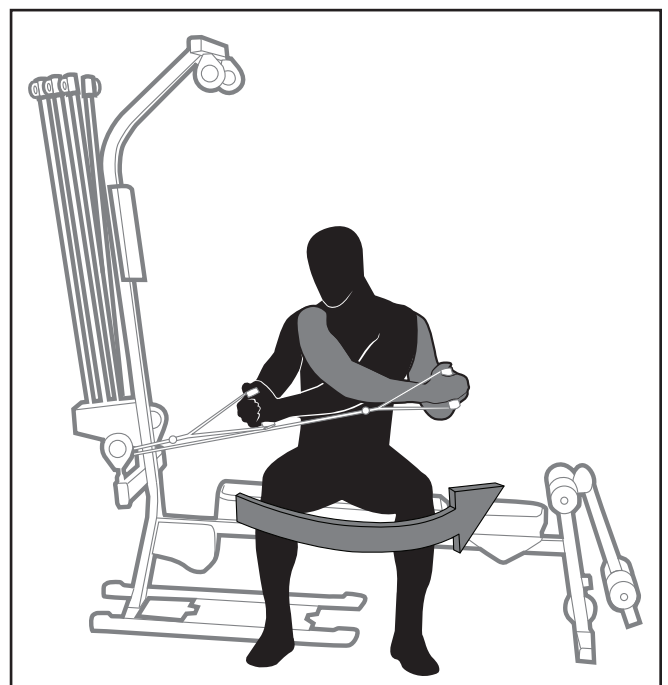

# Exercises

## Leg Exercises

### Leg Extension

#### Muscles Worked

Quadriceps

#### Machine Set-Up

- Adjust to Flat Bench position.
- Use the Leg Extension Seat.
- Leg Extension pulleys
- Attach the clips to the Power Rod® resistance rods.

#### Success Tips

- Use slow, controlled motion. Do not kick into the extension.
- Do not let your knees rotate outward during the exercise. Keep your kneecaps pointing up and straight forward.

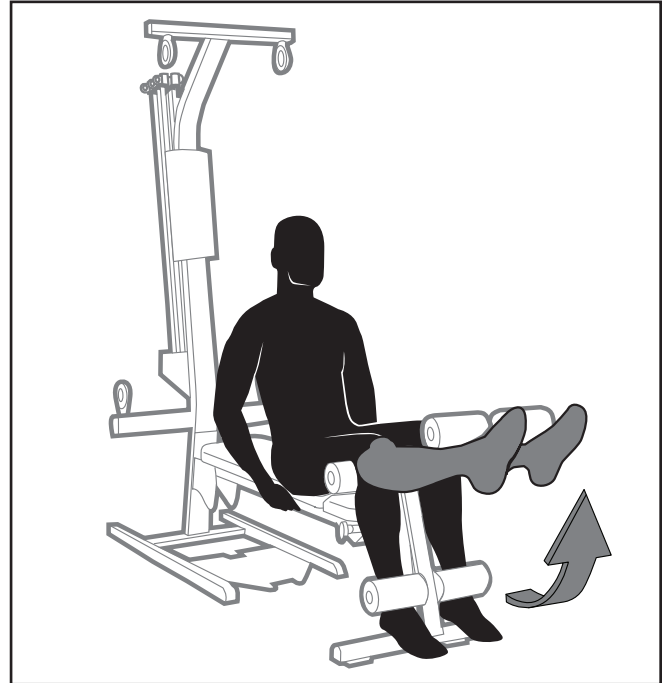

### Calf Raise

#### Muscles Worked

Gastrocnemius, Soleus

#### Machine Set-Up

- Remove bench and seat rail knob.
- Chest Bar pulleys
- Leg Press Belt
- Attach the clips to the Power Rod® resistance rods.

#### Success Tips

- Keep your chest lifted, spine aligned, abs tight and a very slight arch in your lower back.
- Do not bend from hip or waist during movement.
- Push with end of foot to fully extend leg.

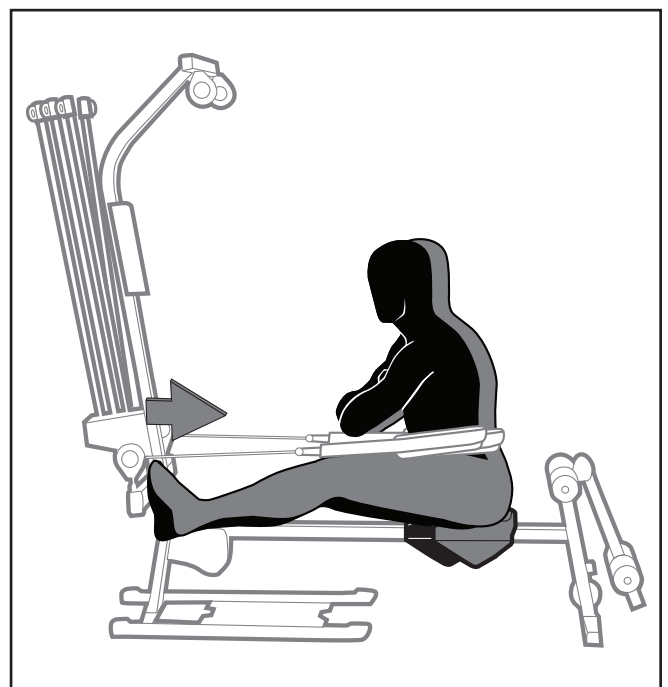

# Exercises

## Leg Exercises

### Seated Hip Adduction

#### Muscles Worked

Adductor Longus, Gluteus Medius

#### Machine Set-Up

- Adjust to Flat Bench position
- Chest Bar pulleys
- Handgrips
- Attach the clips to the Power Rod® resistance rods

#### Success Tips

- Do not cross the attached leg in front of the stabilized leg.
- Keep your abs tight and do not lift your hips or excessively arch your back.
- Keep your spine straight and your hips level. Do not raise your hips during the motion.
- Use only a small range of motion.

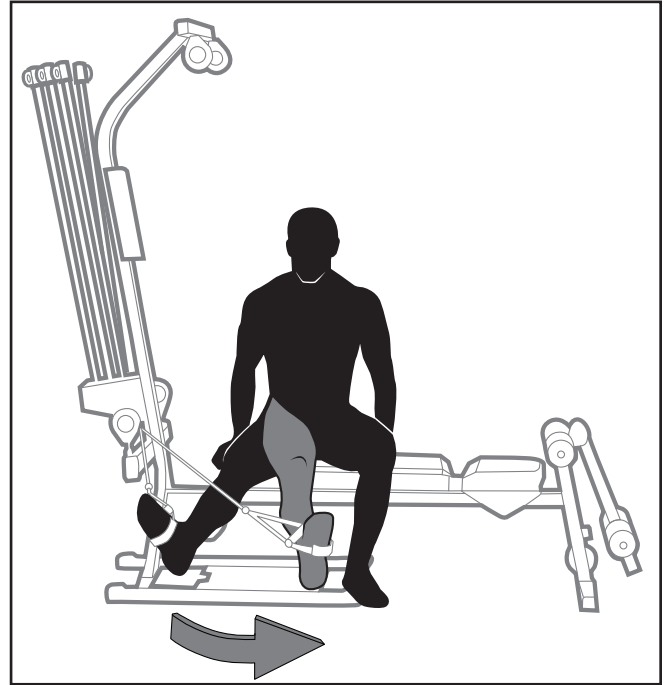

### Seated Hip Abduction

#### Muscles Worked

Piriformis, Gluteus Maximus

#### Machine Set-Up

- Adjust to Flat Bench position.
- Chest Bar pulleys
- Handgrips
- Attach the clips to the Power Rod® resistance rods.

#### Success Tips

- Keep your spine straight and your hips level. Do not raise your hips during the motion.
- Use only a small range of motion.
- Keep your hips motionless throughout this exercise.

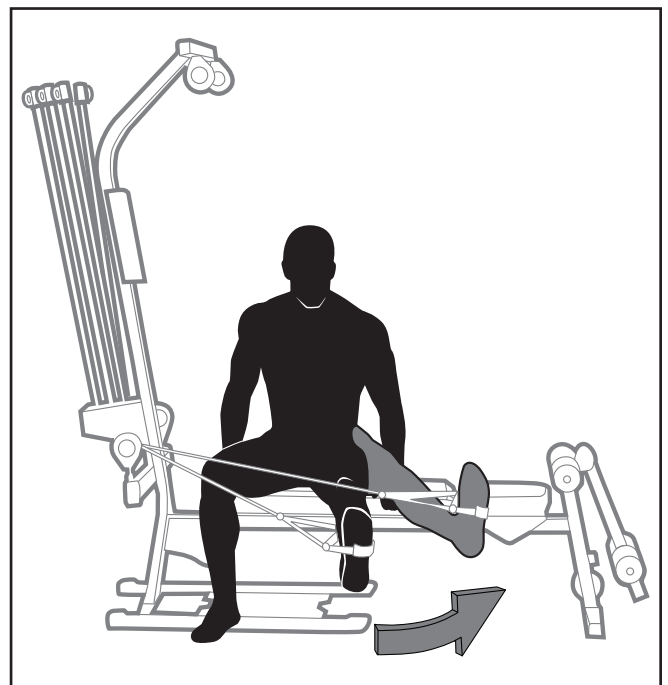

# Exercises

## Leg Exercises

### Standing Leg Kickback - Hip and Knee Extension

#### Muscles Worked

Gluteus Maximus

#### Machine Set-Up

- Adjust to Flat Bench position.
- Chest Bar pulleys
- Handgrips
- Attach the clips to the Power Rod® resistance rods.

#### Success Tips

- Keep your chest lifted, spine aligned, abs tight and a very slight arch in your lower back.
- Do not bend from your waist or lower back.
- Hold on to Lat Tower for stability.
- Keep stabilizer foot on foot plate.



### Leg Press

#### Muscles Worked

Gluteus Maximus

#### Machine Set-Up

- Remove the bench and seat rail knob
- Chest Bar pulleys
- Leg Press Belt
- Attach the clips to the Power Rod® resistance rods

#### Success Tips

- Keep your chest lifted, spine aligned, abs tight and a very slight arch in your lower back.
- Bend from hip during movement, not from waist.

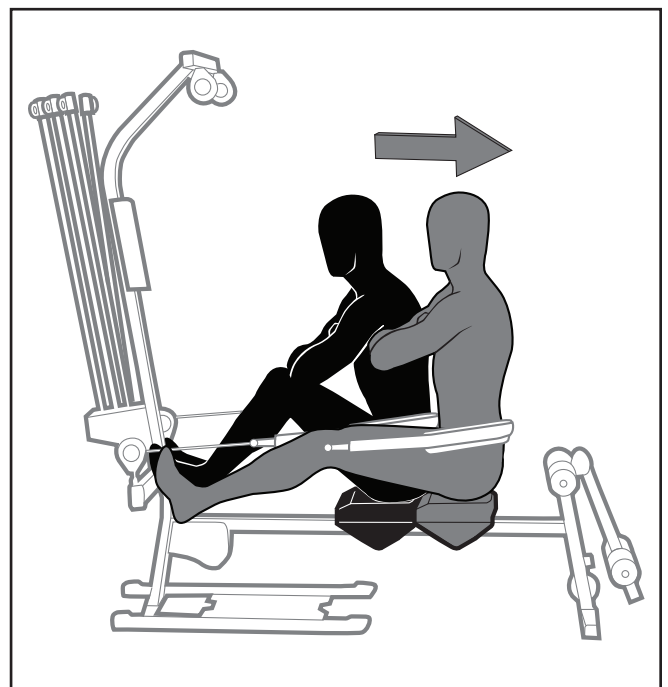











Nautilus, Inc., (800) NAUTILUS / (800) 628-8458, [www.NautilusInc.com](http://www.NautilusInc.com) - Customer Service: North America (800) 605-3369, [customerservice@bowflex.com](mailto:customerservice@bowflex.com) | outside U.S. +01-360-859-5180, [technics-APLA@nautilus.com](mailto:technics-APLA@nautilus.com) | Printed in China | © 2008 Nautilus, Inc.

Nautilus®

Bowflex®

Schwinn® Fitness

Universal®